

Perma-Column Design and Use Guide

(PC4600, PC6300, PC6400, PC6600, PC8300, PC8400 and PC8500 Models)

May 7, 2024

(supersedes all prior versions)



400 Carol Ann Lane
Ossian, IN 46777
PH: 800-622-7190
www.permacolumn.com

By:



Dimitry Reznik, P.E.
Timber Tech Engineering, Inc.
www.timbertecheng.com
email: tte@timbertecheng.com

East: 22 Denver Road, Suite B Denver, PA 17517
717.335.2750 Fax: 717.335.2753

West: 206 S. Main St, P.O. Box 509 Kouts, IN 46347
219.766.2499 Fax: 219.766.2394

Table of Contents

1.	Design Overview	Page 2
2.	Perma-Column Descriptions and Properties	Page 2
3.	Reinforced Concrete Base Column Design	Page 6
4.	Semi-Rigid, Moment-Resisting Steel Bracket Assembly Design	Page 8
5.	Wood Column Design	Page 13
6.	Modeling	Page 15
7.	Perma-Column Design Chart	Page 18
8.	Design Example	Page 22
9.	Soils: Lateral Assessment	Page 24
10.	Soils: Bearing Assessment	Page 25
11.	Soils: Uplift Assessment	Page 25
12.	Summary and Conclusion	Page 27
13.	Calculations	

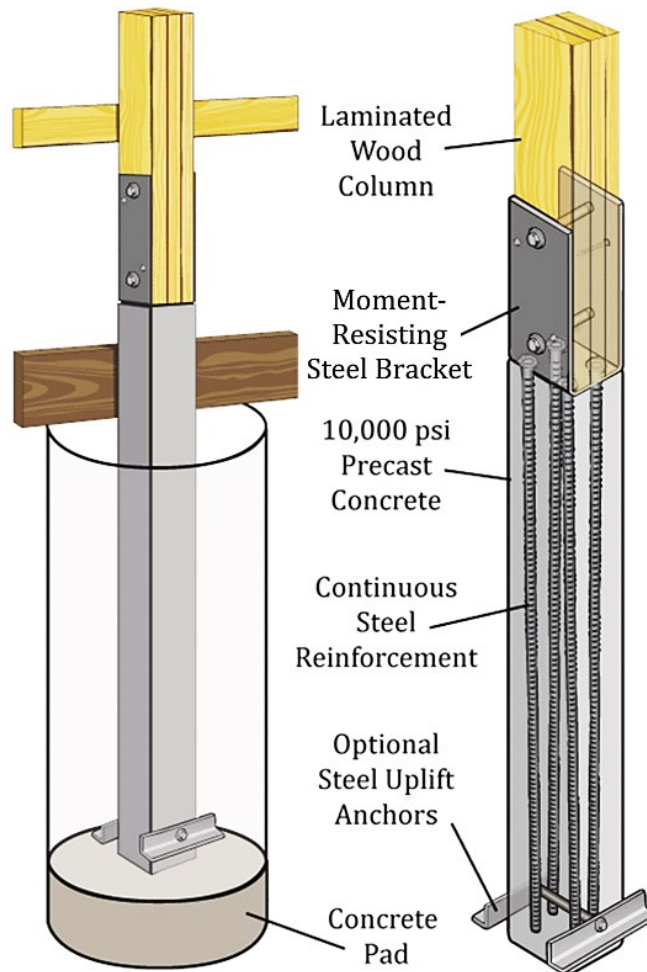

1. Design Overview

This guide is intended to be used by post-frame building engineers and designers as a companion document to the ESR-4238 report by *International Code Council Evaluation Services (ICC ES)*. Each **Perma-Column** assembly consists of:

- A reinforced precast concrete base designed according to the *Building Code Requirements for Structural Concrete (ACI 318-14)* by The American Concrete Institute (ACI).
- A structural semi-rigid, moment-resisting bracket assembly designed according to the *Specification for Structural Steel Buildings (2016th Edition)* by The American Institute of Steel Construction (AISC).
- A laminated or solid sawn wood column component designed according to the *2018 Edition of The National Design Specification for Wood Construction (NDS)* by the American Wood Council (AWC).

Structural analysis is based on load and resistance factor (LRFD) and the allowable strength design (ASD) methodologies in accordance with 2018 International Building Code (IBC). This Design and Use Guide covers properties and design procedures for the reinforced concrete base, the structural semi-rigid moment-resisting steel bracket, and the laminated wood columns. A table showing allowable axial compression strengths (ASD) of the Perma-Column assemblies with nail-laminated and glulam columns is provided. Because of the many assumptions and variables, the table is intended only for preliminary design and cost estimate purposes.

2. Perma-Column Descriptions and Properties

Dimensions and material properties for the PC4600, PC6300, PC6400, PC6600, PC8300, PC8400 and PC8500 models are provided in Table 2.1. Tables 2.2 through 2.4 give dimensions and section properties for several different wood column sizes and types that are included in this report:

- 4x6 solid-sawn
- 6x6 solid-sawn
- 3-ply 2x6, 4-ply 2x6, 3-ply 2x8, 4-ply 2x8 and 5-ply 2x8 mechanically laminated wood columns
- 3-ply 2x6, 4-ply 2x6, 3-ply 2x8, 4-ply 2x8 and 5-ply 2x8 glue-laminated wood columns (glulam)

The mechanically laminated (mech-lam, nail-lam, screw-lam) group consists of #1 Southern Yellow Pine (SYP) lumber using standard dressed sizes (surfaced four sides (S4S)), as well as #1 SYP laminations which have been further planed for better visual appearance. The glulam group consists of SYP laminations which have been planed down as part of standard fabrication process. **Perma-Column** models for use with glulam columns are identified with a “GL” at the end of the name. These models have a reduced inside dimension for tight fit with the glulam products.

Table 2.1: Dimensions and Properties

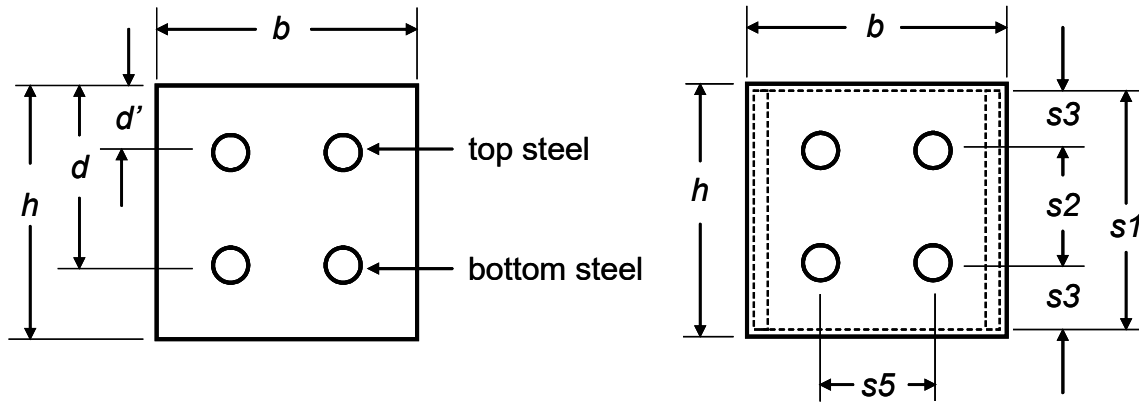

Variable	PC4600	PC6300	PC6400	PC6600	PC8300	PC8400	PC8500
Concrete Width, b (in)	4.50	5.38	6.88	6.38	5.38	6.88	8.31
Concrete Depth, h (in)	5.44	5.44	5.44	5.44	7.19	7.19	7.19
Depth to Top Steel, d' (in)	1.50	1.50	1.50	1.50	1.56	1.56	1.56
Depth to Bottom Steel, d (in)	3.94	3.94	3.94	3.94	5.62	5.62	5.62
Width of Steel Bracket, $s1$ (in)	5.00	5.00	5.00	5.00	7.00	7.00	7.00
Top & Bottom Steel Spacing, $s2$ (in)	2.44	2.44	2.44	2.44	4.06	4.06	4.06
Steel Distance to Bracket Edge, $s3$ (in)	1.28	1.28	1.28	1.28	1.47	1.47	1.47
Area of Top Steel, A_s' (in. ²)	0.40	0.40	0.40	0.40	0.62	0.62	0.62
Area of Bottom Steel, A_s (in. ²)	0.40	0.40	0.40	0.40	0.62	0.62	0.62
Steel Yield Strength, f_y (lbf/in. ²)	60,000	60,000	60,000	60,000	60,000	60,000	60,000
Concrete Comp. Strength, f_c' (lbf/in. ²)	10,000	10,000	10,000	10,000	10,000	10,000	10,000
Steel MOE, E_s (ksi)	29000	29000	29000	29000	29000	29000	29000

Table 2.2: Standard S4S (Surfaced Four Sides) Wood Column Dimensions and Properties

Property	4x6	6x6	3ply x 6	3ply x 8	4ply x 6	4ply x 8	5ply x 8
Width, b (in)	3.50	5.50	4.50	4.50	6.00	6.00	7.50
Depth, d (in)	5.50	5.50	5.50	7.25	5.50	7.25	7.25
Area, A (in ²)	19.25	30.25	24.75	32.63	33.00	43.5	54.38
Section Modulus, S (in ³)	17.65	27.73	22.69	39.42	30.25	52.56	65.70
Moment of Inertia, I (in ⁴)	48.53	76.26	62.39	142.90	83.19	190.54	238.17

Table 2.3: Planed Wood Column Dimensions and Properties

Property	3ply x 6	3ply x 8	4ply x 6	4ply x 8	5ply x 8
Width, b (in)	4.50	4.50	6.00	6.00	7.50
Depth, d (in)	5.31	7.19	5.31	7.19	7.19
Area, A (in ²)	23.90	32.36	31.86	43.14	53.93
Section Modulus, S (in ³)	21.15	38.77	28.20	51.70	64.62
Moment of Inertia, I (in ⁴)	56.15	139.39	74.86	185.85	232.31

Table 2.4: Glulam Column Dimensions and Properties

Property	3ply x 6	3ply x 8	4ply x 6	4ply x 8	5ply x 8
Width, b (in)	4.063	4.063	5.375	5.375	6.72
Depth, d (in)	5.25	7.00	5.25	7.00	7.00
Area, A (in ²)	21.33	28.44	28.22	37.63	47.04
Section Modulus, S (in ³)	18.66	33.18	24.69	43.90	54.88
Moment of Inertia, I (in ⁴)	49.0	116.12	64.81	153.64	192.08

Figure 2.1 shows the orientation of the column laminations in a typical post-frame wall assembly. Wind load is taken by uniaxial bending about axis Y. The provisions of this design guide do not apply to columns subject to biaxial bending. Figure 2.2 is a definition sketch showing embedment depth, orientation of the column, and direction of wind loading on the assembly. The *Perma-Column* assembly is assumed to be braced in the out-of-plane direction by girts spaced 24 inches on center.

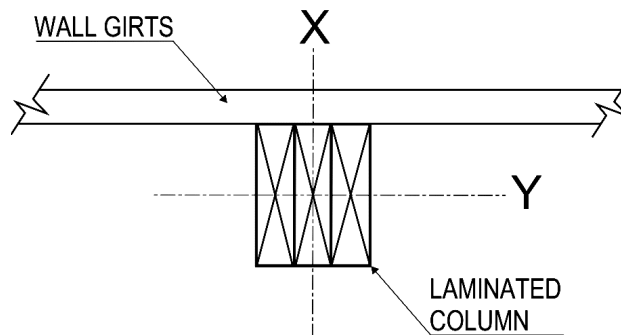

Figure 2.1 Wood Column Orientation

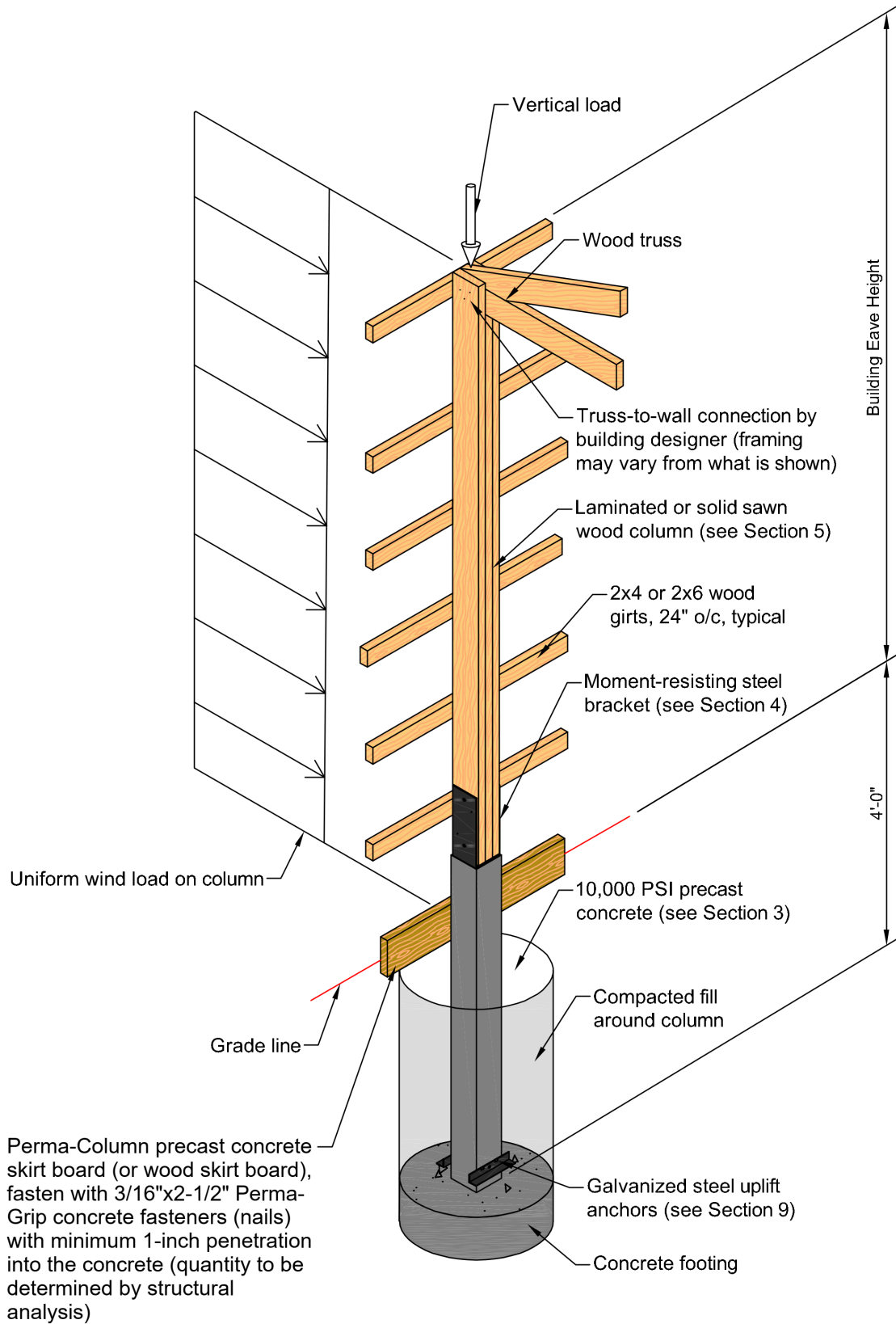

Figure 2.2 *Perma-Column* load definition sketch

3. Reinforced Concrete Base Column Design

The reinforced concrete base of the *Perma-Column* assembly is manufactured with 10,000 psi (nominal) precast concrete and four (4) A706 Grade 60 vertical reinforcing bars. Number 4 bars are used for the PC4600, PC6300, PC6400, and PC6600, while number 5 bars are used for the PC8300, PC8400, and PC8500 models. The required concrete cover for reinforcing bars in precast concrete is less than cast-in-place concrete because of better placement accuracy during the manufacturing process. Each of the *Perma-Column* models meet the minimum concrete cover of 1.25 inches required for precast concrete components that are exposed to earth or weather. The high concrete strength and quality is achieved by adding superplasticizer, which increases strength by allowing a low water-to-cement ratio. Fiber reinforcers are added to reduce shrinkage, increase impact resistance, and increase flexural strength. Other admixtures are included in the concrete mix to increase freeze/thaw resistance, protect the steel reinforcement from rusting, increase flexural and compressive strength, and optimize the hydration process. Bending, axial, tensile and shear strength values of the reinforced concrete base are specified in ESR-4238 and Tables 3.1 and 3.3. The modulus of elasticity of concrete, and the moment of inertia of the cracked concrete for each model are provided in Table 3.2.

Table 3.1: Axial Compression, Bending and Tensile Strength of *Perma-Column* Base

Series	ASD			LRFD		
	P _a (lb)	M _a (ft-lb)	T _a (lb)	φP _n (lb)	φM _n (ft-lb)	φT _n (lb)
PC4600	60,800	4,080	5,630	97,200	6,530	8,460
PC6300	70,700	4,140	6,870	113,100	6,620	10,320
PC6400	87,600	4,200	6,030	140,100	6,720	9,070
PC6600	82,000	4,180	6,230	131,100	6,690	9,360
PC8300	95,700	9,090	10,450	153,100	14,540	15,710
PC8400	118,100	9,240	9,040	188,900	14,790	13,590
PC8500	139,400	9,340	8,210	223,000	14,940	12,340

Table 3.2: Moment of Inertia of Cracked Concrete and Modulus of Elasticity

Series	E _c (psi)	I _{cr} (in ⁴)
PC4600	5700000	16.9
PC6300	5700000	17.8
PC6400	5700000	18.9
PC6600	5700000	18.6
PC8300	5700000	55.9
PC8400	5700000	59.2
PC8500	5700000	61.8

Table 3.3: Shear Strength of Perma-Column Base

LRFD							
	PC4600	PC6300	PC6400	PC6600	PC8300	PC8400	PC8500
P_u	φV_n	φV_n	φV_n	φV_n	φV_n	φV_n	φV_n
(lb)	(lb)	(lb)	(lb)	(lb)	(lb)	(lb)	(lb)
10,000	3,218	3,722	4,610	4,314	5,121	6,386	7,592
9,000	3,162	3,668	4,555	4,260	5,063	6,327	7,533
8,000	3,106	3,614	4,501	4,205	5,004	6,269	7,475
7,000	3,051	3,559	4,447	4,151	4,946	6,210	7,416
6,000	2,995	3,505	4,392	4,097	4,887	6,151	7,357
5,000	2,939	3,451	4,338	4,042	4,828	6,093	7,299
4,000	2,883	3,397	4,284	3,988	4,770	6,034	7,240
3,000	2,827	3,342	4,229	3,934	4,711	5,976	7,181
2,000	2,771	3,288	4,175	3,879	4,653	5,917	7,123
1,000	2,715	3,234	4,120	3,825	4,594	5,858	7,064
0	2,660	3,180	4,066	3,771	4,535	5,800	7,005
-1,000	2,436	2,963	3,849	3,553	4,301	5,566	6,771
-2,000	2,213	2,746	3,631	3,336	4,067	5,331	6,536
-3,000	1,989	2,528	3,414	3,119	3,832	5,097	6,301
-4,000	1,766	2,311	3,196	2,901	3,598	4,862	6,067
-5,000	1,542	2,094	2,979	2,684	3,363	4,628	5,832

ASD							
	PC4600	PC6300	PC6400	PC6600	PC8300	PC8400	PC8500
P	V_a	V_a	V_a	V_a	V_a	V_a	V_a
(lb)	(lb)	(lb)	(lb)	(lb)	(lb)	(lb)	(lb)
6,250	2,011	2,326	2,881	2,696	3,201	3,991	4,745
5,625	1,976	2,292	2,847	2,662	3,164	3,954	4,708
5,000	1,942	2,259	2,813	2,628	3,128	3,918	4,672
4,375	1,907	2,225	2,779	2,594	3,091	3,881	4,635
3,750	1,872	2,191	2,745	2,560	3,054	3,845	4,598
3,125	1,837	2,157	2,711	2,526	3,018	3,808	4,562
2,500	1,802	2,123	2,677	2,492	2,981	3,771	4,525
1,875	1,767	2,089	2,643	2,458	2,944	3,735	4,488
1,250	1,732	2,055	2,609	2,425	2,908	3,698	4,452
625	1,697	2,021	2,575	2,391	2,871	3,662	4,415
0	1,662	1,987	2,541	2,357	2,835	3,625	4,378
-625	1,523	1,852	2,405	2,221	2,688	3,478	4,232
-1,250	1,383	1,716	2,270	2,085	2,542	3,332	4,085
-1,875	1,243	1,580	2,134	1,949	2,395	3,186	3,938
-2,500	1,103	1,445	1,998	1,813	2,249	3,039	3,792
-3,125	964	1,309	1,862	1,677	2,102	2,893	3,645

4. Semi-Rigid, Moment-Resisting Steel Bracket Assembly Design

Figure 4.2 shows dimensions for the different moment-resisting steel bracket assemblies that are used with the *Perma-Column* assemblies. The brackets consist of 1/4" thick A1018, SS designation (Structural Steel) Grade 40 steel with 5/8" diameter holes for the bolts, and 5/16" diameter holes for screws. The bracket connection utilizes 1/2" diameter SAE J429 Grade 5 bolts in double shear with hex nuts torqued to 110 ft-lbs, and 1/4"x3" structural screws by Simpson Strong-Tie equal PC-approved (Perma-Column approved) screws in single shear. The screws have a one-inch long 0.242-inch to 0.249-inch diameter unthreaded shank before the root diameter is reduced at the threads. The highest concentration of stresses is located near the face of the wood column along the unthreaded segment of the screw. The stresses dissipate significantly at the end of the unthreaded shank segment (beginning of threaded segment). When compared to standard wood screws, the SDS and other PC-approved structural screws have a significantly greater shear strength values in a steel-to-wood application. This difference in strength is attributed primarily to two factors: SDS and other PC-approved screws have a high specified bending yield strength and a long large-diameter unthreaded shank. Typically, one screw is installed from each side of the bracket at each bolt, except the PC8300, PC8400 and PC8500 have two screws on each side at each bolt. These screws strengthen the connection and help prevent stress concentrations around the bolt which could cause splitting of the wood members. The wood column bears directly on a 1/4" steel seat plate which helps to transfer axial loads into the concrete base. Four A706 weldable reinforcing bars are inserted in holes in the bottom of the bracket and fillet-welded to the steel bracket and the steel seat plate, connecting the bracket to the concrete base.

4.1 Bracket (Joint) Moment Strength

The steel bracket, which serves a joint between the wood column and concrete base, has significant bending moment strength and should not be modeled as a pin (see Section 4.2). Bracket is attached to the concrete base below and the wood column above and the bending strength of both elements concrete-to-bracket and the bracket-to-wood must be evaluated in order to determine the overall moment strength of the joint.

The reinforcing bars transfer shear and moment forces between the concrete base and the steel bracket. The allowable bending strength (ASD) and design bending strength (LRFD) of the concrete-to-steel bracket connection is provided in Table 4.1a.

The moment force from the wood column is transferred into the steel bracket via the top and bottom fastener groups in the bracket (Figure 4.1). The lateral strength (shear strength) of the fasteners (NDS yield equations), not the steel bracket, controls the bending strength of the bracket-to-wood column element. The wood-to-steel connection was analyzed per the National Design Specification for Wood Construction 2018 edition by the American Wood Council using Southern Yellow Pine wood columns (Specific Gravity = 0.55). The allowable bending strength (ASD) and the design bending strength (LRFD) of the bracket-to-wood connection is provided in Table 4.1b. The bending strength in Table 4.1b has been adjusted by the load duration factor C_D of 1.6 (ASD) and the time effect factor λ of 1.0 (LRFD) in accordance with NDS for short duration loads (wind).

With exception of PC6400, the steel bracket-to-wood column connection controls the bending strength of the joint between the wood column and the concrete base. Values from Tables 4.1a and 4.1b are merged in Table 4.1c to represent the entire joint: concrete-to-bracket and bracket-to-wood elements.

Table 4.1a: Concrete-to-Steel Bracket Connection Bending Strength (ft-lb)

Series	Design Bending Strength (LRFD) ϕM_n	Allowable Bending Strength (ASD) M_n/Ω
PC4600	3,910	2,600
PC6300	3,910	2,600
PC6400	3,910	2,600
PC6600	3,910	2,600
PC8300	6,700	4,460
PC8400	6,700	4,460
PC8500	6,700	4,460

Table 4.1b: Steel Bracket-to-Wood Column Connection Bending Strength (ft-lb)

Series	Design Bending Strength (LRFD) ϕM_n	Allowable Bending Strength (ASD) M_a
PC4600	2,800	2,080
PC6300	2,800	2,080
PC6400	4,500	3,340
PC6600	2,800	2,080
PC8300	5,550	4,120
PC8400	5,550	4,120
PC8500	5,550	4,120

Notes:

1. For Southern Pine lumber or timber (Specific Gravity = 0.55 or greater)
2. Dry service conditions ($C_M = 1.0$)

Table 4.1c: Bending Strength of the Joint Between Wood Column and Concrete Base (ft-lb)

Series	Design Bending Strength (LRFD) ϕM_n	Allowable Bending Strength (ASD) M_a
PC4600	2,800	2,080
PC6300	2,800	2,080
PC6400	3,910	2,600
PC6600	2,800	2,080
PC8300	5,550	4,120
PC8400	5,550	4,120
PC8500	5,550	4,120

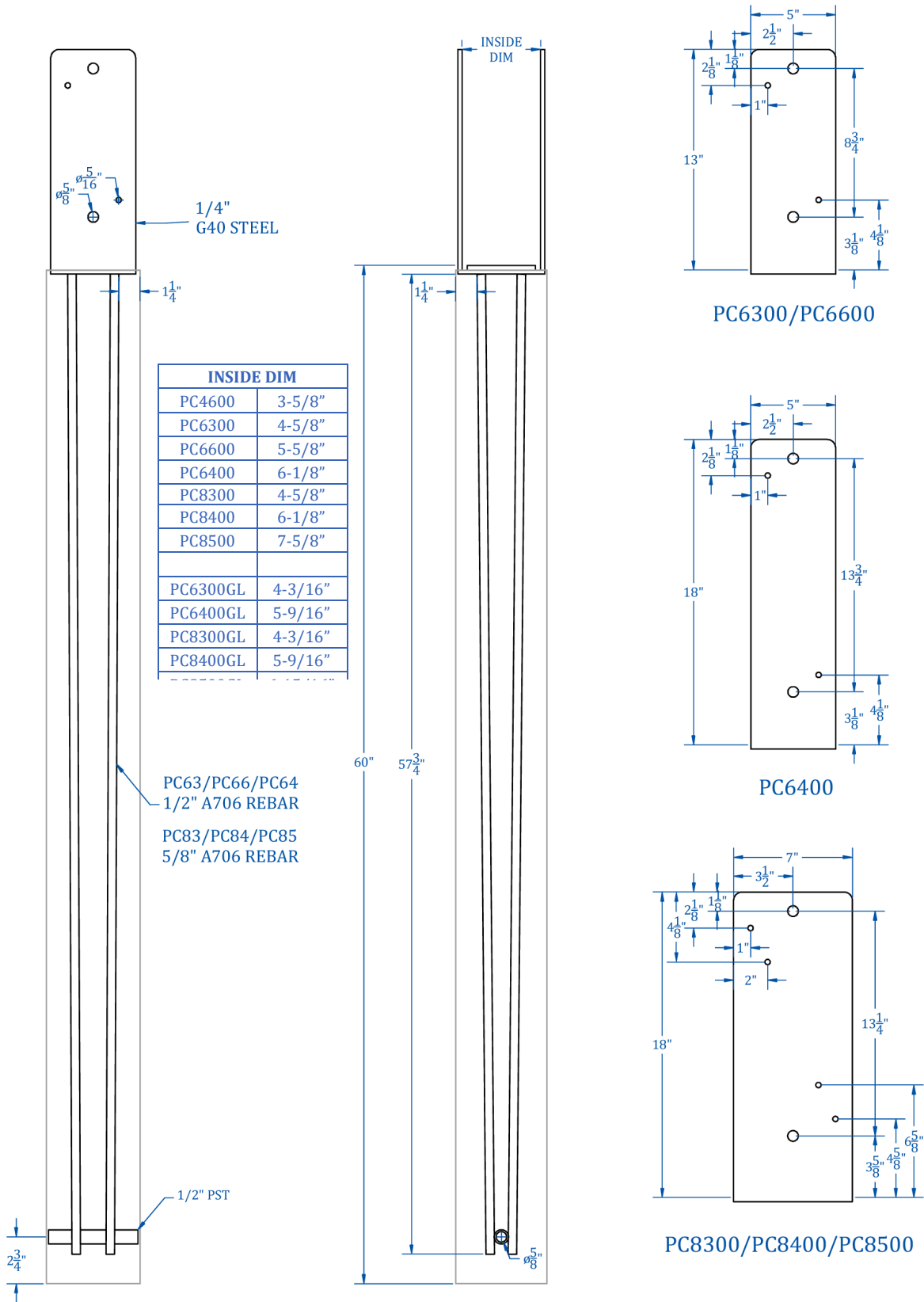

Figure 4.2 Structural Reinforcing Bracket Assemblies

4.2 Bracket (Joint) Rotational Stiffness

The effective rotational stiffness of the joint between the wood column and the concrete base, as defined by slip-modulus of the dowel fasteners in the steel-to-wood connection, flexing of the steel saddle under load, axial deformation in the tension rebar under load, and other contributors, is provided in Table 4.2.

Table 4.2: Rotational Stiffness of the Joint, M/θ

Series	(ft-lb/rad)	(ft-lb/degrees)
PC4600	166,670	3,030
PC6300	166,670	3,030
PC6400	212,500	3,780
PC6600	162,500	3,000
PC8300	391,670	6,930
PC8400	383,330	6,770
PC8500	375,000	6,620

4.3 Bracket (Joint) Shear Strength

The shear strength of each PC steel bracket is provided in Table 4.3. The wood-to-steel connection was analyzed per the National Design Specification for Wood Construction 2018 edition by the American Wood Council using Southern Yellow Pine wood columns (Specific Gravity = 0.55). The shear strength in Table 4.3 has been adjusted by the load duration factor C_D of 1.6 (ASD) and the time effect factor λ of 1.0 (LRFD) in accordance with NDS for short duration loads (wind). Wet service reductions have not been applied since the wood portion is not in contact with the soil or concrete and the column is assumed to be used in an enclosed building. If the columns are to be used in an environment where the moisture content of the wood in service will exceed 19% for an extended period of time, pressure treated wood and galvanized or stainless steel bolts should be used, and a wet service factor should be applied.

Table 4.3: Shear Strength of the Joint Between Wood Column and Concrete Base (lb)

Series	Design Shear Strength (LRFD) ϕV_n	Allowable Shear Strength (ASD) V_a
PC4600	2,830	2,100
PC6300	2,830	2,100
PC6400	3,200	2,380
PC6600	2,830	2,100
PC8300	4,080	3,030
PC8400	4,080	3,030
PC8500	4,080	3,030

4.4 Bracket (Joint) Combined Shear and Bending Loading

A concrete foundation (soil and concrete backfill) must be designed in accordance with ASABE EP486 to resist the shear, uplift, bending (moment) and downward forces that are transferred from the *Perma-Column* into the soil. The foundation (soil and concrete backfill) must have sufficient rotational rigidity to ensure that the inflection point, a point of zero moment, is located above the steel bracket (the joint) – not below (Figure 14.1). The latter requirement ensures that shear and bending forces may be applied to the steel bracket simultaneously without any reduction to the maximum shear and maximum moment strength reported in Sections 4.1 and 4.3. The maximum shear and moment strength values in these sections are not applicable to load cases where this requirement is not satisfied.

In Figure 4.4B, Load Case 1 defines the maximum shear strength, V_{max} , of the column-to-bracket connection in absence of moment forces. Load Case 2 defines the maximum moment strength, M_{max} , of

the column-to-bracket connection in absence of shear forces. Load Case 3 is a combination of Load Case 1 and Load Case 2 where a maximum moment and a maximum shear force are applied to the steel bracket simultaneously. In all load cases, the maximum shear strength, V_{max} , and the maximum moment strength, M_{max} , are defined such that the magnitude of the resulting forces F_T (force at the top fastener group) and F_B (force at the bottom fastener group) does not exceed the lateral strength of each respective fastener group.

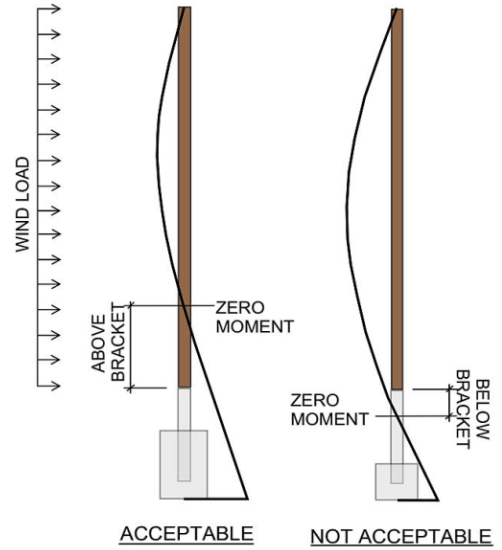

Figure 4.4A

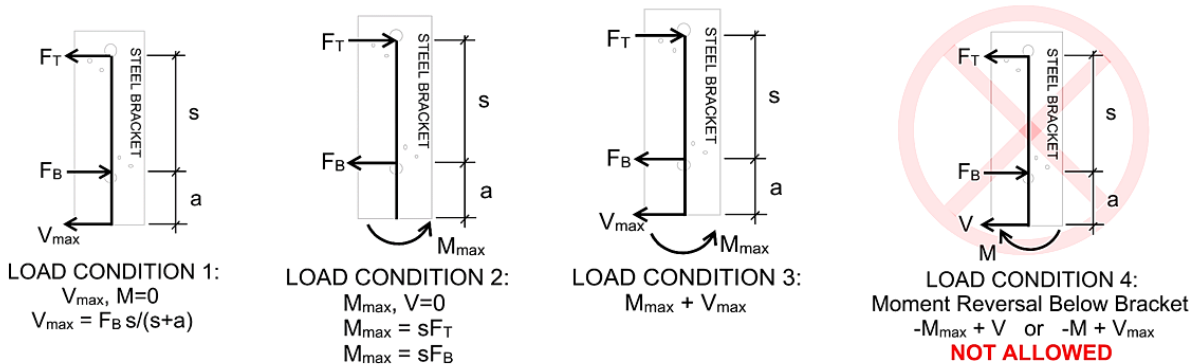

Figure 4.4B

The resulting forces F_T and F_B in Load Case 1 are acting in opposite directions from the resulting forces F_T and F_B in Load Case 2. This means that adding a shear load to the connection that is loaded with the maximum moment force will result in reduction in forces F_T and F_B . Similarly, adding a moment force to the connection that is loaded with the maximum shear force will result in reduction in forces F_T and F_B . Therefore, when the inflection point (point of zero moment) is located above the steel bracket, V_{max} and M_{max} loading may be applied to the steel bracket simultaneously without any reduction in strength. Load Case 4 represents the condition in which the

moment reversal occurs below the bracket. In this load condition, M_{max} , as determined by Load Condition 2, cannot be used in combination with a shear force of any magnitude and V_{max} , as determined by Load Condition 1, cannot be used in combination with a moment force of any magnitude. With load condition, as shear force increases moment strength decreases, and as moment force increases shear strength decreases. Therefore, when the inflection point (point of zero moment) is located below the steel bracket, V_{max} and M_{max} loading may NOT be applied to the bracket simultaneously without any reduction in strength. This condition is rare and should not occur when foundation (soil, concrete backfill) is correctly designed.

4.5 Bracket (Joint) Uplift Strength

The uplift strength of each PC steel bracket is provided in Table 4.5. The wood-to-steel connection was analyzed per the National Design Specification for Wood Construction 2018 edition by the American Wood Council using Southern Yellow Pine wood columns (Specific Gravity = 0.55). The uplift strength in Table 4.5 has been adjusted by the load duration factor C_D of 1.6 (ASD) and the time effect factor λ of 1.0 (LRFD) in accordance with NDS for short duration loads (wind). Wet service reductions have not been applied since the wood portion is not in contact with the soil or concrete and the column is assumed to be used in an enclosed building. If the columns are to be used in an environment where the moisture content of the wood in service will exceed 19% for an extended period of time, pressure treated wood and galvanized or stainless steel bolts should be used, and a wet service factor should be applied.

Table 4.5: Uplift Strength of the Joint Between Wood Column and Concrete Base (lb)

Series	Design Uplift Strength (LRFD) ϕV_n	Allowable Uplift Strength (ASD) V_a
PC4600	6,515	4,835
PC6300	6,515	4,835
PC6400	6,515	4,835
PC6600	6,515	4,835
PC8300	11,450	8,490
PC8400	11,450	8,490
PC8500	11,450	8,210

5. Wood Column Design

The design of the wood portion of the *Perma-Column* assembly is governed by NDS (2015) *National Design Specification for Wood Construction* by American Wood Council. The design of mechanically laminated columns is governed by ASABE EP559.1 *Design Requirements and Bending Properties for Mechanically-Laminated Wood Assemblies*. The design in Table 7.1 is for #1 SYP solid sawn timber columns, #1 SYP mechanically laminated columns and SYP glulam columns. The unadjusted design values for #1 SYP timber and mechanically laminated columns are provided in NDS tables and Table 5.1. The unadjusted design values for glulam columns provided in Table 5.2 are based on Visually Graded Southern Pine, Combination 49 (Grade N1M16, NDS Table 5B). Table 5.3 contains adjustment factors to be applied to the wood design values. The orientation of the mechanically laminated columns and glulam columns is as described in Section 2 and shown in Figure 2.1.

Table 5.1: #1 SP Wood Column Design Values

Property	4x6	6x6	3ply x 6	3ply x 8	4ply x 6	4ply x 8	5ply x 8
Flexure, F_b (psi)	1350	1350	1350	1250	1350	1250	1250
Shear, F_v (psi)	175	165	175	175	175	175	175
Axial Compression, F_c (psi)	1550	825	1550	1500	1550	1500	1500
Modulus of Elasticity, E ($\times 10^6$ psi)	1.6	1.5	1.6	1.6	1.6	1.6	1.6
Minimum MOE, E_{min} ($\times 10^6$ psi)	0.58	0.55	0.58	0.58	0.58	0.58	0.58

Table 5.2: SP Glulam Column Design Values (Combination 49, Grade N1M16)

Property	3ply x 6	3ply x 8	4ply x 6	4ply x 8	5ply x 8
Flexure, F_b (psi)	1750	1750	1950	1950	1950
Shear, F_v (psi)	260	260	260	260	260
Axial Compression, F_c (psi)	1450	1450	2100	2100	2100
Modulus of Elasticity, E ($\times 10^6$ psi)	1.7	1.7	1.7	1.7	1.7
Minimum MOE, E_{min} ($\times 10^6$ psi)	0.90	0.90	0.90	0.90	0.90

Wet service reductions are not used in this design since the wood portion is not in contact with the soil or concrete and is assumed to be used within an enclosed building. The design assumes no splices in the wood laminations. Axial load is assumed to be transferred by direct bearing on the seat plate and not through bolts or screws.

Table 5.3: Adjustment Factors for Design Values

Adjusted Design Values	ASD only	ASD and LRFD								LRFD only		
	Load Duration Factor	Wet Service Factor (Dry)	Temperature Factor	Beam Stability Factor	Size Factor	Flat Use Factor	Repetitive Member Factor (Not used for Glulam Columns)		Column Stability Factor	Format Conversion Factor	Resistance Factor	Time Effect Factor
							C_r (VG, ASAE EP559.1)					
	C_D (NDS)	C_M (NDS)	C_t (NDS)	C_L (NDS)	C_F (NDS)	C_{fu} (NDS)	3-ply	4-ply & 5-ply	C_P (NDS)	K_F	ϕ	λ
$F_b' = F_b$	x	1.60	1.00	1.00	1.00	1.00	1.35	1.40	-	2.54	0.85	Varies
$F_v' = F_v$	x	1.60	1.00	1.00	-	-	-	-	-	2.88	0.75	
$F_c' = F_c$	x	1.15	1.00	1.00	-	1.00	-	-	Varies	2.40	0.90	
$E' = E$	x	-	1.00	1.00	-	-	-	-	-	-	-	
$E_{min}' = E_{min}$	x	-	1.00	1.00	-	-	-	-	-	1.76	0.85	

6. Modeling

Figure 6.1 shows an example of the structural analogs for the *Perma-Column* assembly. Structural analysis for Table 7 was completed in the Visual Analysis by Integrated Engineering Software. The structural analog consists of the *Perma-Column* concrete base, the wood column, and the joint between the concrete base and the wood column (Figure 6.1). At the top, the wood column is laterally restrained by a spring representing the roof diaphragm. Below grade, the concrete base is restrained by a system of springs in accordance with the *Universal Method* of ASABE EP486.3 (non-constrained shallow post foundation). Each spring represents a lateral stiffness relationship between the concrete base and the soil at respective spring location. Springs are spaced at 6 inches on center and are assigned a varying degree of stiffness based on medium to dense consistency of well-graded mixture of fine- and coarse-graded soil (glacial till, hardpan, boulder clay, GW-GC, GC-SC). The increase in Young's Modulus per unit depth below grade, A_E , is assumed to be 300 (lb/in²)/in, which is double the value in Table 1 of EP486.3 as the water table is assumed to be below the foundation. Per EP486.3, springs with resulting forces greater than forces defined by the ultimate lateral strength of soil, F_{ult} , are replaced by F_{ult} and $F_{ult}/0.6$ using LRFD and ASD methodologies, respectively.

The analysis behind Table 7.1 is based on soil type and consistency described in this guide. The designer may use an analog similar to what is presented in this guide to predict the behavior of the *Perma-Column* assembly under many different soil and load conditions.

Column deflection limits, as specified in *IBC 2018 Table 1604.3*, are $L/240$ and $L/120$ for exterior walls with brittle and flexible finishes, respectively. The location of the maximum deflection along the length of the column is affected by soil properties, rigidity of the roof diaphragm and flexural rigidity of the column assembly and typically varies from near mid-length of the column to eave of the building. For example, a short column in a building with a very flexible roof diaphragm, when loaded, will exhibit a curvature similar to a cantilevered column (flag-pole). A column in a building with an infinitely rigid roof diaphragm (no lateral displacement at eave) will have a loaded curvature similar to the Structural Analog 1 in Figure 6.1. Most columns, however, will fall somewhere in between these two extremes as shown by the Structural Analog 2 in Figure 6.1. Regardless of the curvature characteristics, the maximum deflection found anywhere along the length of the column should not exceed the deflection limits specified in the IBC. The IBC deflection limits are to be used with *service loads* or service load combinations. Prior to 2010th edition, ASCE 7 wind load calculations were based on *serviceability wind speeds* and resulted in an unfactored wind load W . The wind load calculations in 2010th and later editions are based *ultimate wind speeds* and the resulting wind load W is a factored load. For this reason, ASCE 7-16 Commentary provides *serviceability wind speed maps* and labels the resulting *service wind loads* as W_a . The factored wind load W and the service wind load W_a for the same location are separated by a factor of 0.6 which is calculated as V_s^2 / V_u^2 , where V_s is the serviceability wind speed, and V_u is the ultimate wind speed. For example, a Risk Category II ultimate wind speed for Ohio is 110 mph (ASCE 7-16, Figure 26.5-1B) and serviceability wind speed is 82 mph (ASCE 7-16, Figure CC.2-2). The resulting relationship between the ultimate and service wind load is calculated as: $82^2 / 110^2 = 0.556$ or 0.6 when rounded to the nearest one tenth. To eliminate the need for another layer of wind load calculations, it is permissible to replace W_a with $0.6W$:

$$\text{Governing Serviceability Load Combination: } D+0.6W \quad (\text{Eq. 6-1})$$

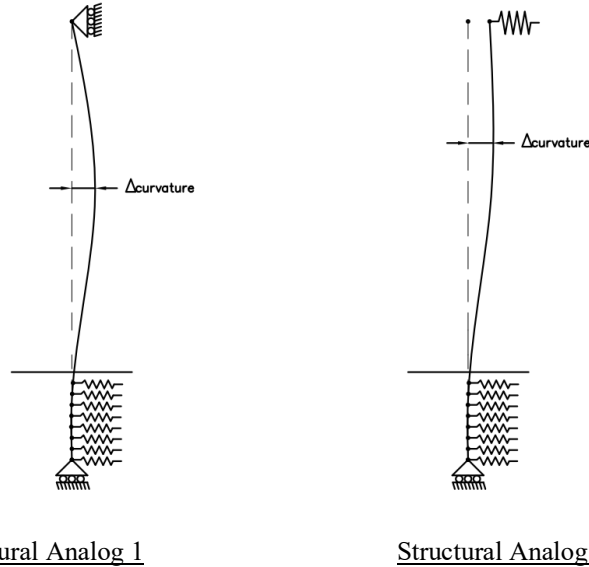

Figure 6.1 Structural Analogs for a Typical Post Frame Column

The concrete base of each *Perma-Column* should be modeled using the concrete modulus of elasticity E_c , of 5,700,000 psi. The *Gross Moment of Inertia*, I_g , of the concrete base is constant, approximated by the standard expression $I_g = bh^3/12$, until the bending in the concrete causes concrete to crack. After concrete cracks, the moment of inertia drops rapidly then tapers off as it approaches the lower limit defined by the *Cracked Moment of Inertia*, I_{cr} (Figure 6.2). Selecting a precise moment of inertia value based on bending moment in the concrete base is difficult and unproductive as bending moments vary and are affected by internal variables such as stiffness of the joint and stiffness of the wood column and external factors such as stiffness of soils and stiffness of the roof diaphragm – all determined using theoretic analysis and many assumptions. The accuracy of such analysis cannot be verified. For columns used in typical post-frame application, it is acceptable to model the *Perma-Column* concrete base using profile dimensions defined by the Cracked Moment of Inertia, I_{cr} , using the base profile dimensions provided in Table 6.1. The designer may also need to consider a model with uncracked concrete base using full profile dimensions for the Perma-Column base component. The latter model may result in higher internal bending moment at the bracket and in the concrete base and higher bending and shear load demand on the foundation (soil). The former (cracked) model will likely produce greater deflections in the column assembly, larger positive internal bending moment in the wood column and larger horizontal load demand on the roof diaphragm.

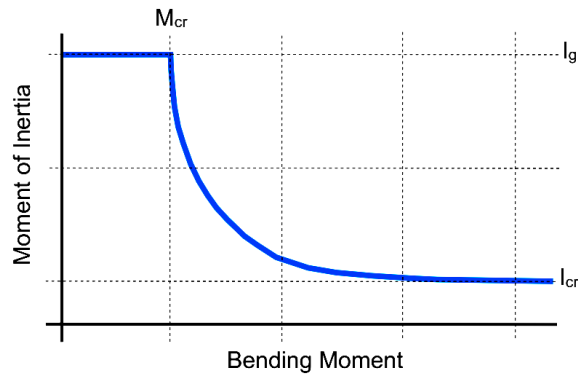

Figure 6.2 Moment of Inertia of the Perma-Column Concrete Base

Table 6.1: Recommended Profile Dimensions for Modeling the Concrete Base

Series	Width (in)	Depth (in)
PC4600	3.77	3.77
PC6300	3.82	3.82
PC6400	3.88	3.88
PC6600	3.86	3.86
PC8300	5.09	5.09
PC8400	5.16	5.16
PC8500	5.22	5.22

In the structural computer program, the joint between the concrete base and the wood column should be modeled as a “semi-rigid joint” using rotational rigidity values in Table 4.2. If the computer program does not have the ability to model semi-rigid joints directly, the designer may create a *joint member* in between the concrete base and the wood column with carefully selected structural and geometrical properties to mimic the behavior of the semi-rigid joint using the equation 6-2.

$$EI = (M/\theta)_e L \quad (\text{Eq. 6-2})$$

Where,

E = elastic modulus of the *joint member*

I = moment of inertia of the *joint member's* profile

L = length of the *joint member*

$(M/\theta)_e$ = effective rotational rigidity of the *joint member*
 $= [1/(M/\theta)_b + 1/(M/\theta)_w]^{-1}$

$(M/\theta)_b$ = rotational stiffness of the steel bracket (Table 4.2)

$(M/\theta)_w$ = rotational rigidity of the wood segment that is
 being replaced by *joint member*

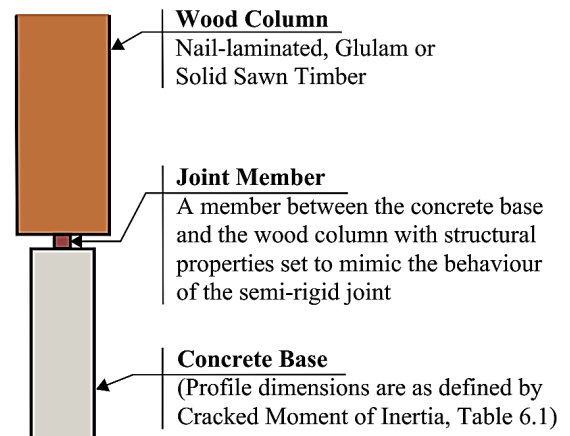

Figure 6.3 Joint Member between concrete base and wood column

Table 6.2 shows the recommended properties for the vertical joint member that is 1 inch long and is made of steel (E=29,000,000 psi). For example, the semi-rigid joint between the 3-ply 2x6 wood column and the PC6300 concrete base can be modeled as a 1-inch-long, 0.948-inch-wide and 0.948-inch-deep vertical member, made of steel material (for ex. ASTM A36), rigidly connected to the concrete base and the wood column. The joint in this example will produce the same results as the joint that is assigned a rotational stiffness value in Table 4.2.

Table 6.2: Recommended Joint Member Properties

Series	Width (in)	Depth (in)	Length (in)	E (psi)
PC4600	0.948	0.948	1.0	29,000,000
PC6300	0.948	0.948	1.0	29,000,000
PC6400	1.009	1.009	1.0	29,000,000
PC6600	0.944	0.944	1.0	29,000,000
PC8300	1.175	1.175	1.0	29,000,000
PC8400	1.170	1.170	1.0	29,000,000
PC8500	1.165	1.165	1.0	29,000,000

7. *Perma-Column* Design Chart

Table 7.1 shows the Allowable Vertical Load, P_a , (ASD) for *Perma-Column* assemblies under a uniform wind load of 160 pounds per linear foot (plf), wind loads calculated per ASCE 7-16. The 160 plf wind load is based on 115 mph ultimate wind speed for Risk Category II buildings, Wind Exposure C, building mid-height up to 32 feet, 4:12 roof pitch and 8-foot o/c column spacing (design wind pressure is 20 psf). The notes at the bottom of Table 7.1 describe the assumptions and conditions to which these vertical loads apply. The post heights evaluated range from 12'-0" up to 24'-0" in two-foot increments. The failure modes checked are as follows:

1. Deflection Due to Service Loads
2. Wood Elements (NDS 2015, EP559)
 - a. Axial load
 - b. Bending moment
 - c. Shear load
 - d. Combined axial load and bending moment
3. Steel Bracket (bending moment)
4. Concrete Base
 - a. Axial load
 - b. Bending moment
 - c. Shear load

The restraint conditions at grade level and at the top of the *Perma-Column* assembly used in post-frame applications are most similar to a propped cantilever. The effective length coefficient, K_e , a quantity related to the buckling characteristics of a compression member, is determined while member is in pure axial-compression mode (external bending forces are not present). When lateral forces are not present, the *Perma-Column* assembly is expected to exhibit a buckling behavior specific to a propped cantilever. The recommended effective length coefficient for a propped cantilever is 0.8 (Table G1, NDS 2018). The *Perma-Column* assemblies are not designed for "flag pole" installations where no lateral support at the top of the post can be expected.

All structural analogs used for Chart 7.1 have a lateral support at the top of the post to simulate resistance to horizontal loads by the roof diaphragm. Two models are considered for each column: (1) a column assembly with a vertical roller at the top of the column with zero lateral displacement at eave and (2) a column assembly with a spring support at the top of the column allowing some lateral displacement. Both restraint conditions are shown in Figure 6.1. The lateral stiffness of the spring at the top of the column assembly is set such that the maximum deflection anywhere along the length of the column does not exceed the deflection limits of $L/120$ for walls with flexible finishes (metal siding and or metal liner) and $L/240$ for wall with brittle finishes (stucco, stone veneer, glass wall, drywall).

In some circumstances, the calculated loads may exceed the capacity of a single *Perma-Column* assembly (for example a column on each side of a large door opening) and columns may need to be doubled as shown in Figure 7.1. When columns are doubled, the vertical load capacities reported in Table 7.1 may also be doubled.

Table 7.1 is limited to columns embedded into the soil with properties as described in Section 6: medium to dense consistency of well-graded mixture of fine- and coarse-graded soil (glacial till, hardpan, boulder clay, GW-GC, GC-SC). The stiffness of the soil is approximated using horizontal springs spaced at 6 inches o/c as described in Section 6. The specified axial capacities in Table 7.1 are contingent on assumed strength and stiffness of the roof diaphragm at the top of the *Perma-Column* column assembly and the shallow post foundation at bottom of the assembly. A roof diaphragm that is more flexible than what is assumed in this design, or a foundation with more rigid or less rigid rotational properties, may significantly affect (reduce) the axial capacities reported in Table 7.1. Hence, the axial capacities of columns are variables – not constants. Values in Table 7.1 are mid-field representatives of how the *Perma-Column* assemblies are expected to perform in common post-frame structures. Table 7.1 is intended for estimate (preliminary design) and pricing purposes only. The final column design should include a complete building analysis by a design professional.

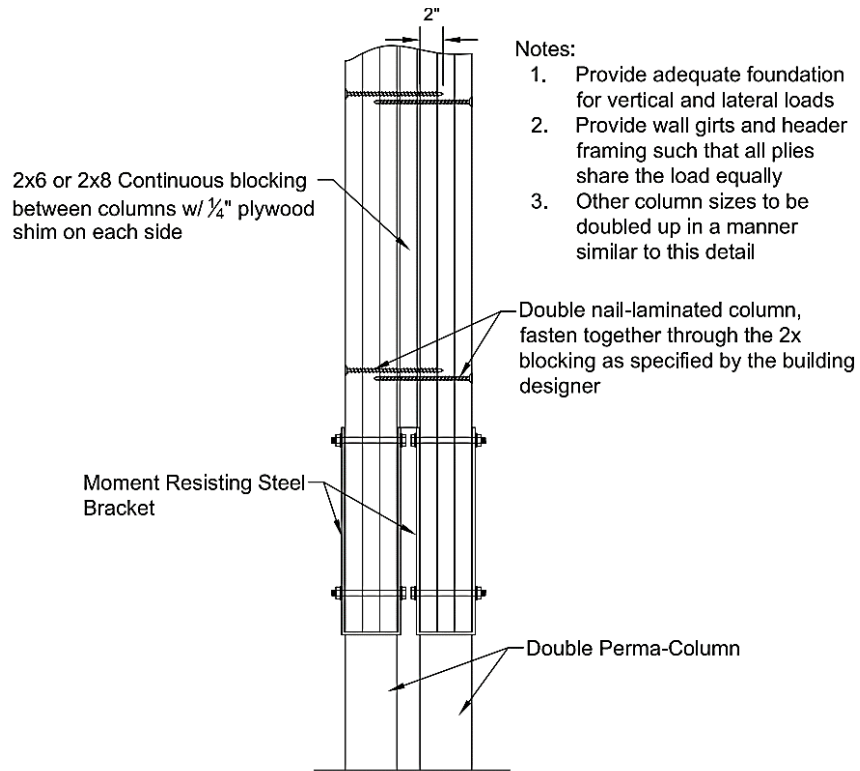

Figure 7.1 Double Perma-Column installation detail

Table 7.1 Perma-Column Design Chart - Allowable Strength Design (ASD)

Building Eave Height (ft)			Allowable Vertical Load on Column Under Constant Wind Load						
			12	14	16	18	20	22	24
			$\Delta = L/120 \text{ \& } L/240$		$\Delta = L/120 \text{ ONLY (walls with flexible finishes)}$				
#1 SYP Std. Dressed	PC4600	4x6 #1 SYP	13,400	8,350	5,050				
	PC6600	6x6 #1 SYP	20,300	14,800	10,250				
	PC6300	3 ply x 6	20,650	14,100	9,700				
	PC6400	4 ply x 6	29,350	20,700	14,700	10,650			
	PC8300	3 ply x 8	39,850	33,650	26,000	19,450	14,400	11,050	
	PC8400	4 ply x 8	52,950	44,800	37,100	28,050	21,450	16,700	13,000
	PC8500	5 ply x 8			47,000	36,900	28,500	22,600	17,650
#1 SYP planed	PC6300	3 ply x 6	18,400	12,450	8,450				
	PC6400	4 ply x 6	26,400	18,250	13,000	9,350			
	PC8300	3 ply x 8	39,650	33,650	25,350	18,850	14,100	10,700	
	PC8400	4 ply x 8	52,950	44,800	36,350	27,450	20,800	16,200	12,600
	PC8500	5 ply x 8			46,550	36,150	27,650	21,650	17,300
Glulam (Comb. 49)	PC6300	3 ply x 6	23,300	15,600	10,350				
	PC6400	4 ply x 6	35,500	24,600	17,000	12,000			
	PC8300	3 ply x 8	41,250	38,550	31,450	23,350	17,100	13,000	
	PC8400	4 ply x 8	72,050	61,050	47,100	35,250	26,750	20,600	16,050
	PC8500	5 ply x 8			61,900	46,750	35,750	28,000	22,100
			Allowable Vertical Load on Traditional Embedded Wood Columns						
#1 SYP Std. Dressed	PC4600	4x6 #2 SYP	9,700	5,500	n/a				
	PC6600	6x6 #2 SYP	13,100	9,150	5,800				
	PC6300	3 ply x 6	18,600	13,100	9,100	n/a	n/a	n/a	n/a
	PC6400	4 ply x 6	25,700	18,500	13,450	10,150	n/a	n/a	n/a
	PC8300	3 ply x 8	38,300	30,200	22,700	17,100	13,050	10,200	n/a
	PC8400	4 ply x 8	51,900	42,700	32,400	24,900	19,300	15,350	12,250
	PC8500	5 ply x 8			41,700	32,450	25,550	20,400	16,500

(Notes and assumptions for Table 7.1 are listed on next page)

Table 7.1 Assumptions:

- 1) Table 7.1 is intended only for preliminary design and cost estimate purposes. The table may not be used for the final design, purchase or construction. This table may not be used or referenced in the design calculations. The building designer assumes all responsibility for the final design.
- 2) This chart is for Perma-Column assemblies used in a normal post-frame building (enclosed on all four sides) where columns are supported at the top by a roof diaphragm.
- 3) Design conforms with IBC 2018. ASCE 7-16 Wind design criteria: Risk Category II, Wind Exposure C, Enclosed Building, 32ft max mid-height, 4:12 (max) roof pitch, 115 mph wind speed, 160 lb/ft wind load on columns spaced 8ft o/c.
- 4) Southern Pine and Spruce-Pine-Fir design values are per NDS 2015 Tables 4A, 4B and 4D . Glulam design values per NDS 2015 Table 5B (Combination 49, N1M16)
- 5) IBC 2018 (ASCE 7-16) Load combinations used are: 1) Dead + Snow, 2) Dead +.75(0.6Wind+Snow) 3) Dead+0.6Wind
- 6) See Tables 2.2, 2.3 and 2.4 for member dimensions and properties
- 7) Dead load to total load ratio = 0.25
- 8) Buckling Length Coefficient, K_e , is 0.8
- 9) Deflection limits are $L/240$ (blue) and $L/120$ (yellow) based on larger of side-sway or curvature.
- 10) Repetitive member factor for 3-ply nail laminated column is 1.35. Repetitive member factor for 4-ply and 5-ply nail-laminated columns is 1.4 per ASABE EP559. The repetitive factor does not apply to solid sawn timber and glulam columns.
- 11) Dry use factor applied to wood portion in Perma-Column assembly; wet use factor applied to the embedded segment of the traditional embedded solid sawn and nail-laminated columns
- 12) Full lateral bracing and major axis bending only; no loads acting on weak axis; no knee-braces; no splices in laminated wood portion of Perma-Column assembly
- 13) Non-constrained post foundation designed per ASABE EP 486.3 with 4'-0" embedment depth and properly sized concrete footer and collar.
- 14) Final column design should include a complete building analysis by a Design Professional

8. Design Example

This design example is for a PC8300 with a 3 ply 2x8 #1 Southern Pine planed, mechanically laminated wood column. The wall columns are 16ft tall as measured from floor to eave of the building. When the building is subjected to the maximum wind load, the roof diaphragm has a lateral deflection of 0.6 inches at the mid-length of the building (a given in this example). The walls are covered with brittle finishes (L/240 deflection limit). The vertical load on a typical sidewall column is 5,000 lb dead load and 15,000 lb snow load (given). The horizontal wind loading is 160 plf (given). All assumptions listed in the chart apply to this example. The structural analog is shown in Figure 8.1. The shallow post foundation includes a 2-foot thick (tall) concrete collar. Two cases should be considered:

- Case 1: The stiffness of the top spring, a spring representing load resistance from the roof diaphragm, is set to infinity (zero deflection at the eave).
- Case 2: The stiffness of the spring set such that the eave deflection under D+0.6W load combination is 0.6 inches (given).

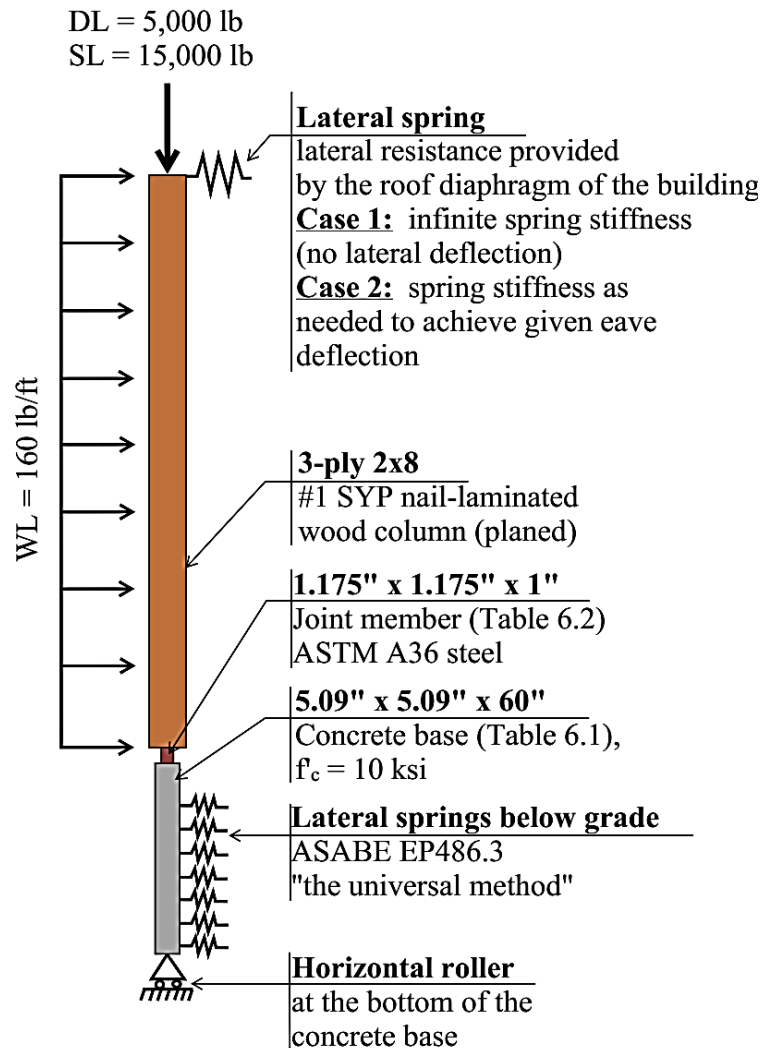

Figure 8.1 Structural analog for Design Example

In this example, the structural model is analyzed in Visual Analysis 18 by IES. The deflected shape for both cases are shown in Figure 8.2 (D+0.6W load combination). Table 8.1 summarized internal axial, bending and shear forces for the Perma-Column concrete base, the steel bracket, and the wood column as reported by Visual Analysis 18.

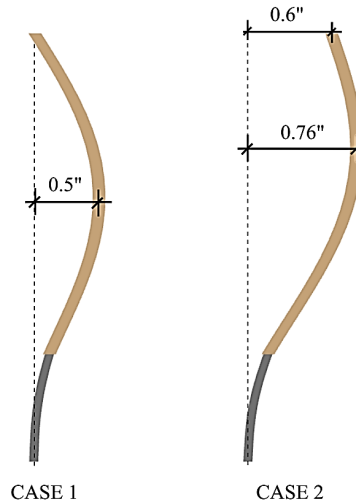

Figure 8.2 Exaggerated deflected shape for Case 1 and Case 2 model (Visual Analysis, IES)

Table 8.1: Maximum Internal Forces in Wood Column, Steel Bracket and Concrete Base

Member	CASE 1			CASE 2		
	Compression (lb)	Bending (ft-lb)	Shear (lb)	Compression (lb)	Bending (ft-lb)	Shear (lb)
Wood Column	20,000	2,325	770	20,000	2,160	780
Steel Bracket (joint member)	n/a	780	770	n/a	1,150	780
Concrete Base	20,000	2,280	1,390	20,000	2,700	750

Shear in the PC concrete base is measured at a distance “d” above the top of the concrete collar. The controlling ASD load combinations for the given dead, snow, and wind loading are as follows

- 1) D + (0.6)W (Pure bending loading and deflection)
- 2) D + S (Pure axial compression loading)
- 3) D + 0.75S + 0.75(0.6)W (Combined compression and bending loading)

The wood column design is governed by the combined axial compression and bending loading. Visual Analysis 18 reports that the column is loaded to 72% of the allowable strength (PASS). The maximum allowable deflection $\Delta = L/240 = (16 \text{ ft})(12 \text{ in/ft}) / 240 = 0.8$ is greater than the calculated deflection in Figure 8.2 (PASS). Moving down the assembly, the bending strength of the steel bracket in Tables 4.1c is greater than the calculated maximum bending load in Table 8.1 (PASS). The shear strength of the steel bracket (Table 4.3) is greater than the calculated maximum shear load in the bracket (PASS). The inflection point (location of zero moment) is located above the steel bracket as required by Section 4.4 to apply shear and moment forces to the bracket simultaneously (PASS). The axial compression, bending and shear strengths of the *Perma-Column* concrete base in Tables 3.1 and 3.3 are greater than the calculated loading in Table 8.1 (PASS). The column assembly is adequate for the design loading.

For a preliminary design (cost estimate and similar purposes), the designer may reference Table 7.1, provided that all assumptions of Table 7.1 are satisfied. The allowable axial load on the 3-ply 2x8 #1 SYP planed 16-foot tall column is 25,350 lbs, which is greater than the required 20,000 lbs load (PASS). Per Table 7.1, the column

satisfies L/240 deflection requirement (PASS). The designer will need to verify these results independently before purchasing the columns; Table 7.1 may NOT be used or referenced in the final design.

9. Soils: Lateral Assessment

The analysis of the shallow post foundations with the *Perma-Column* is the same as one with traditional embedded wood posts. The lateral strength and stability analysis of soils is governed by ASABE EP 486.3. Figures 9.1 and 9.2 show a non-constrained and constrained shallow post foundations, respectively. The non-constrained shallow post foundation is a foundation with no concrete slab or other permanent constraint at grade, while the constrained shallow post foundation does have such a constraint. In most constrained cases, the column/pier is not permanently attached to the concrete slab as is recommended to prevent concrete cracking due to differential settlement. When the column is pulled away from the building under suction wind loads, the concrete slab is no longer effective, and the foundation is designed as non-constrained shallow post foundation.

EP 486.3 provides two design methods: The Universal Method (EP 486.3, Clause 8.3) and the Simplified Method (EP 486.3, Clause 8.4). The simplified method can only be used if the restrictions outlined in Clause 8.4 are satisfied. Shallow post foundations with concrete collars (concrete backfill) do not satisfy the stipulations of the Simplified Method and are analyzed using the Universal Method. The Universal Method utilizes a series of lateral springs along the length of the column/pier foundation below grade, each representing the load response from the layer of soil in which the spring is located. Each spring is assigned a stiffness value calculated in accordance with EP486.3. If the resulting spring force exceeds the ultimate lateral strength of the respective soil layer, the spring is removed and replaced by a constant force. For the analysis and design of the column/pier, this constant force is equal to the ultimate lateral strength of the soil layer calculated per EP 486.3. At this stage of the analysis, the spring replacement force is not reduced by the factor of safety (ASD) or the design strength reduction factor (LRFD). The ultimate lateral strength represents the upper limit of the elastic behavior of the soil layer beyond which the soil reaction force remains constant even as the soil may continue to deform. It may take several iterations to replace each “failing” spring one by one until all remaining spring forces are equal to or less than the ultimate lateral soil strength at each layer (Figure 9.1). If all springs have been replaced and static equilibrium has not been achieved, the concrete collar (backfill) can be increased in thickness (height) and/or diameter as required.

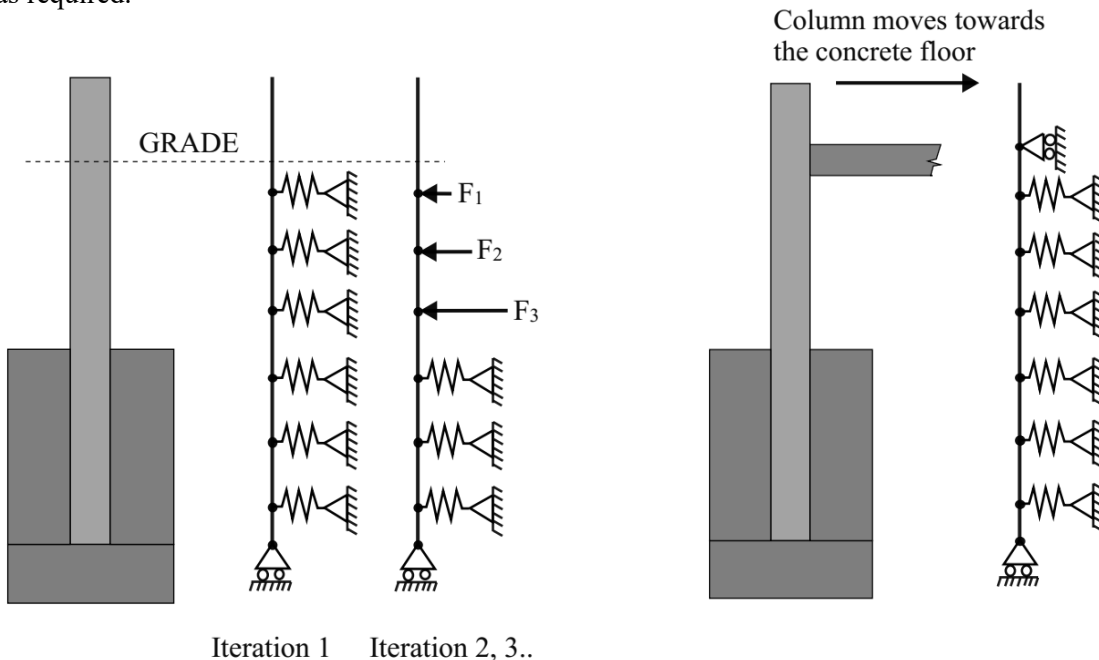

Figure 9.1: Non-Constrained Foundation

Figure 9.2: Constrained Foundation

The designer should also check the lateral strength of soils, an analysis that requires a separate structural analog (model) one that is similar to the structural analogs in Figures 9.1 and 9.2 except that (1) the structural analog is cut off at grade, (2) the internal shear and bending moment forces from the column/pier analysis, as measured at grade, are applied to the soils structural model as external lateral and moment forces at grade, and (3) each spring that exceeds the allowable (ASD) or design (LRFD) lateral strengths of the respective soil layer is replaced by the allowable lateral soil strength force (ASD) or the design lateral strength force (LRFD). This is different from the model used for the analysis of the column/pier where the replacement force was based on the ultimate soils strength. The allowable lateral soil strength (ASD) and the design lateral soil strength (LRFD) are determined by dividing the ultimate lateral soil strength by the factor of safety (ASD) or multiplying the ultimate lateral soil strength by the strength reduction factor (LRFD), respectively. The analysis based on the lateral soil strength may result in concrete collar (backfill) that is larger than what was required for the analysis of the column/pier.

10. Soils: Bearing Assessment

The bearing strength of shallow post foundations is governed by ASABE EP 486.3 Chapter 10 and includes allowable strength design (ASD) and load and resistance factor design (LRFD) methodologies. EP 486.3 includes provisions for different soil types and consistencies and includes prescriptive design values and values obtained through different testing methods. Some building officials, however, will not accept EP 486.3 soil bearing values and will provide values they deem acceptable for the location of the project and allow no increases with depth or width of the footing. Foundation designer should verify acceptable bearing pressures with the local authorities.

11. Soils: Uplift Assessment

The uplift strength of shallow post foundations is governed by ASABE EP 486.3 Chapter 12. The uplift resistance is achieved via the weight of the concrete mass around the column/pier (concrete collar if present and concrete footer if attached to *Perma-Column* via the PC Extender) and the weight of the displaced soil cone. Per EP 486.3, the weight of the soil cone is divided by the factor of safety (ASD) or multiplied by the uplift strength reduction factor (LRFD) while the weight of the attached concrete mass is not reduced. The uplift resistance provided by the displaced soil cone is defined in Section 12.5 and includes provisions for different soil types and conditions and round and square or rectangular uplift devices (round concrete collar, steel uplift angles).

Figures 11.1 and 11.2 show three foundation conditions that may be used with a *Perma-Column*: (1) steel uplift angles, (2) concrete collar and (3) PC Extender. The allowable uplift strength (ASD) and the design uplift strength (LRFD) of the foundation should be taken as the lesser of two, the uplift strength of the concrete mass and the soil cone calculated per EP 486.3 or the uplift strength of the Perma-Column assembly as defined in Table 11.1.

Table 11.1: Tensile Strength of *Perma-Column* Assembly (lb)

Series	Steel Angles with ½” A307 Bolt		Concrete Collar with #4 60 ksi Rebar		PC Extender ½” A307 Bolt		PC Extender ½” A325 Bolt	
	(ASD) T_a	(LRFD) ϕT_n	(ASD) T_a	(LRFD) ϕT_n	(ASD) T_a	(LRFD) ϕT_n	(ASD) T_a	(LRFD) ϕT_n
PC4600	1,410	2,120	4,835*	6,515*	4,800	6,515*	4,835*	6,515*
PC6300	1,410	2,120	4,835*	6,515*	4,800	6,515*	4,835*	6,515*
PC6400	1,410	2,120	4,835*	6,515*	4,800	6,515*	4,835*	6,515*
PC6600	1,410	2,120	4,835*	6,515*	4,800	6,515*	4,835*	6,515*
PC8300	1,410	2,120	8,480	11,440	4,800	8,640	8,480	11,440
PC8400	1,410	2,120	8,480	11,440	4,800	8,640	8,480	11,440
PC8500	1,410	2,120	<u>8,210</u>	11,440	4,800	8,640	<u>8,210</u>	11,440

Footnotes for Table 11.1:

1. Values for the Steel Angles are governed by the bending strength of the angles.
2. Values for the Concrete Collar and PC Extender presented with regular font are governed by the shear strength of the fastener (bolt/rebar) at the bottom of the *Perma-Column*.
3. Italicized values are governed by the lateral strength of the fasteners attaching the steel U-bracket to wood column (SP)
4. Underlined values are governed by the bending strength of the steel U-bracket (bending due to tensile load)
5. Values followed by an asterisk are governed by 1/8" deflection limit of the U-bracket established through testing

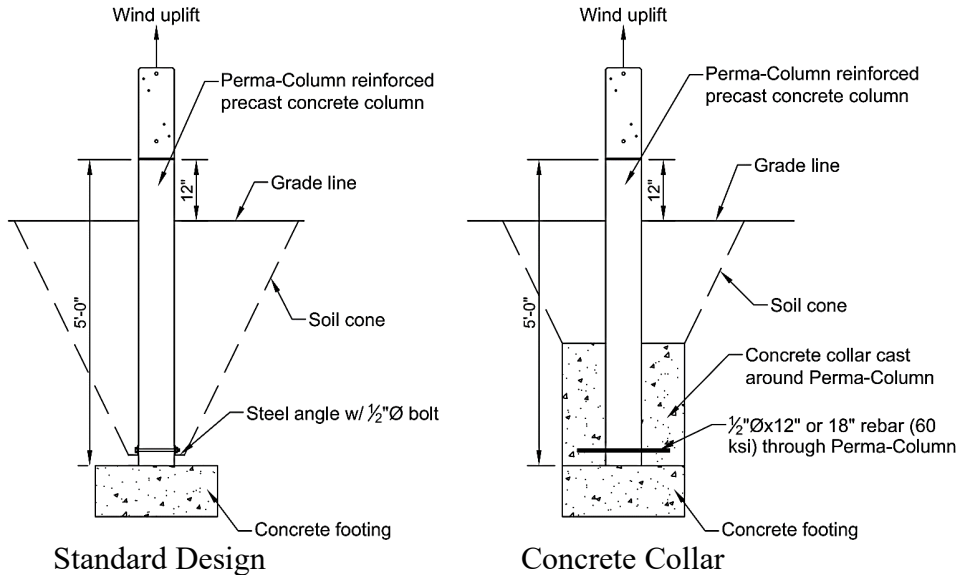

Figure 11.1: Standard Foundation and Foundation with Concrete Collar

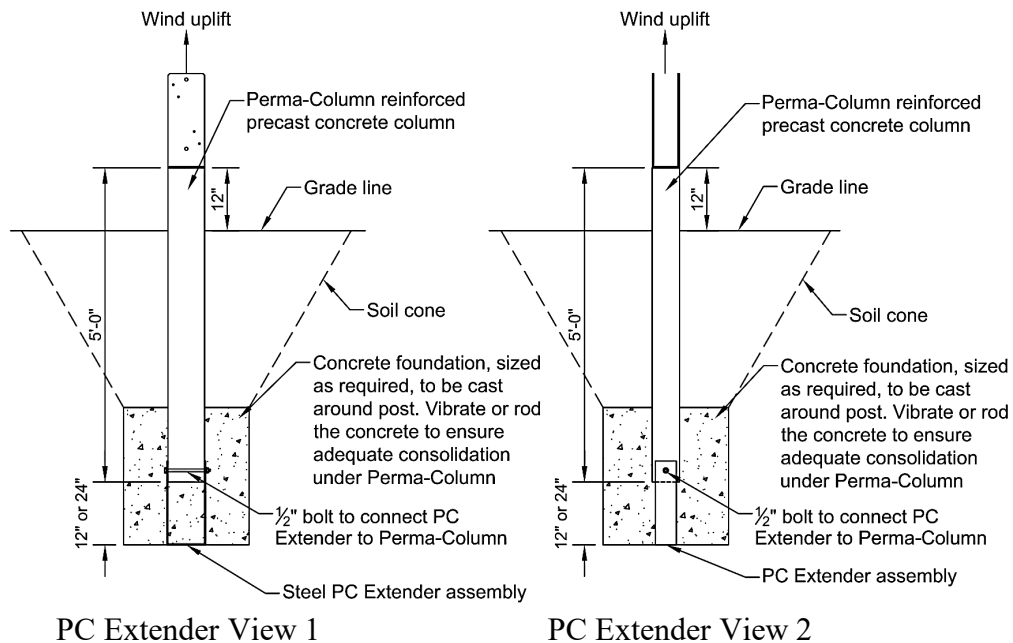

Figure 11.2: Foundation with PC Extender

12. Summary and Conclusion

The *Perma-Column* assembly is designed to be the main structural column in a post-frame building and can be used as an alternative to embedded wood posts. Self-Compacting Concrete (SCC) technology makes it possible to manufacture a high-quality pre-cast concrete product with a low water-to-cement ratio. The 10,000 psi (nominal) compressive strength protects the reinforcing bars by limiting chips and cracks during handling; reduces the effect of freeze-thaw cycles; and provides a smooth, attractive finish. The moment resisting steel bracket assembly can be designed as a moment connection that is capable of resisting loads for most post-frame building applications, and it allows for the use of non-treated wood by keeping the laminations above grade. The wood portion of the *Perma-Column* assemblies can be any grade or species of lumber, and can be used with different types of wood shapes. This guide contains #1 Southern Pine and #2 and better Spruce-Pine-Fir lumber using selected sizes of solid sawn, mechanically laminated and glulam shapes. According to data in Table 7.1, The *Perma-Column* assembly will enhance the structural performance of the wood counterpart it replaces for decades.

Each *Perma-Column* component can be modeled using a structural analog with properties provided in this guide to simulate the *Perma-Column* performance in post-frame buildings of various spans and heights. This guide contains the necessary tools and direction needed to create a structural model. The calculations used to produce Table 7.1 indicate that the *Perma-Column* assemblies are limited primarily by overall deflection, and by the strength of the laminated wood members. There are several foundation detail options including concrete collars, steel uplift angles, and foundation extenders that can be used with a *Perma-Column* to achieve adequate resistance to lateral, gravity and uplift loads for most applications. The *Perma-Column* is a permanent foundation solution for the post-frame building market.



“THE PERMANENT SOLUTION”

PERMA-COLUMN

PC4600, PC6300, PC6400, PC6600, PC8300, PC8400 and PC8500 models

CALCULATIONS

(Revision 7)

IBC 2018

ACI 318-14

ANSI/AISC 360-16

ANSI/AWC NDS 2018

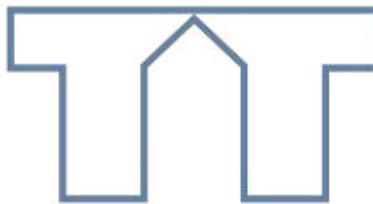

timbertech

ENGINEERING

TTE Project Number E060-18

Prepared by

Dimitry Reznik, P.E.
Timber Tech Engineering, Inc
dar@timbertecheng.com

April 2, 2022

www.timbertecheng.com

Revision 1:

Original calculations for shear strength of the Perma-Column were based on ACI 318-14 provisions for Plain Structural Concrete. The shear strength calculations in this set (Revision 1, Section 4) are updated per ACI 318 equation 22.5.5.1. Only Section 4 is affected by this change.

Revision 2:

Section 2 is updated to include bending strength of the Concrete Column about the x-axis (a graphic is added to define axes). Section 4 is updated to include shear strength of the Concrete Column parallel to z-axis (a graphic is added to define axes).

Revision 3:

Shear strength of Perma-Column concrete foundation in Section 4 is modified to account for effects of axial compression and tension forces.

Revision 4:

Section 9, addressing skirt board fasteners, is added to the calculations.

Revision 5:

Corrections made to Section 7 to address combined shear and moment loads on the steel bracket. NDS 2015 reference on the cover page updated to NDS 2018 on cover page.

Revision 6:

PC4600 model added to the calculations

Revision 7:

Summary Table 5H added to Section 5. This new table provides reduced uplift (tension) values to PC 4600, 6300, 6400 and 6600 models per latest test that limits tensile capacity at 1/8" displacement. Previous Tables 5H and 5I were renamed to 5I and 5J respectively.

1. PERMA-COLUMN: REINFORCED CONCRETE AXIAL STRENGTH

Perma-Column is embedded into the ground and, with the exception of a short segment above grade, is laterally restrained along the full length by surrounding compacted soils. Having continuous lateral restraint, the Perma-Column is a "short column" with design axial strength, ϕP_n , defined in ACI 318 Sections 10.5, 22.4, Table 22.4.2.1, and Equation 22.4.2.2. The profile section dimensions, however, are too small to fit ties or stirrups. To address this concern, the 0.80 multiplier in Table 22.4.2.1 is reduced to 0.60. This reduction factor is a ratio of the design axial strength of the plain structural concrete to the design axial strength of the reinforced concrete column without the 0.80 multiplier. In other words, with this multiplier, the design axial strength of the reinforced Perma-Column is equal to the design axial strength of the plain structural concrete column with the same geometry and concrete properties.

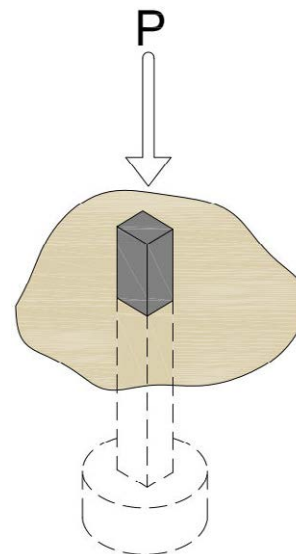

ACI 318 allows the use of plain structural concrete for a pedestal, which is defined as a "member with a ratio of height-to-least lateral dimension less than or equal to 3, used primarily to support axial compressive load." ACI 318 commentary section R14.3.3.1 clarifies that the said ratio applies only to the unsupported height - distance from grade to top of concrete column (pedestal). The Perma-Column is embedded into the ground with only approximately 12" or shorter segment exposed above the ground.

The calculations are completed using the Load Resistance and Factor Design (LRFD) consistent with the ACI 318 adopted method, and the results are presented in terms of the Design Axial Strength. The Design Axial Strength in the calculations below is also converted to the Allowable Axial Strength using the conversion factor $\alpha = 1/1.6 = 0.625$. The calculations are completed in Microsoft Excel (2016) using the listed equations.

GOVERNING CODE:

Building Code Requirements for Structural Concrete, ACI 318

GOVERNING EQUATIONS:

Design Axial Strength	$\phi P_n = \phi 0.60 [0.85f'_c (A_g - A_s) + f_y A_s]$	(ACI 318, 10.5, 22.4.2.1, Eq. 22.4.2.2)
Strength Reduction Factor	$\phi = 0.65$	(ACI 318, Table 21.2.2, b)
Concrete comp. strength, f'_c	10000 psi	
Steel yield strength, f_y	60000 psi	
LRFD to ASD Conversion Factor	$\alpha = 1/1.6 = 0.625$	

CALCULATIONS:

TABLE 1: AXIAL STRENGTH OF REINFORCED CONCRETE COLUMN

Model ID	Width (in)	Depth (in)	Reinforcement	A_g (in ²)	A_s (in ²)	A_c (in ²)	P_n (lbs)	ϕ	LRFD ϕP_n (lbs)	α	ASD $P_{allowable}$ (lbs)
PC4600	4.50	5.44	(4) #4 Rebar	24.5	0.80	23.7	149568	0.65	97200	0.625	60800
PC6300	5.38	5.44	(4) #4 Rebar	29.3	0.80	28.5	173983	0.65	113100	0.625	70700
PC6400	6.88	5.44	(4) #4 Rebar	37.4	0.80	36.6	215599	0.65	140100	0.625	87600
PC6600	6.38	5.44	(4) #4 Rebar	34.7	0.80	33.9	201727	0.65	131100	0.625	82000
PC8300	5.38	7.19	(4) #5 Rebar	38.7	1.24	37.4	235595	0.65	153100	0.625	95700
PC8400	6.88	7.19	(4) #5 Rebar	49.5	1.24	48.2	290599	0.65	188900	0.625	118100
PC8500	8.31	7.19	(4) #5 Rebar	59.7	1.24	58.5	343035	0.65	223000	0.625	139400

* $A_c = A_g - A_s$

2. PERMA-COLUMN: REINFORCED CONCRETE BENDING STRENGTH

Perma-Column is manufactured with 10,000 psi concrete and reinforced with (4) #4 and #5 Grade 60 longitudinal rebar. The design bending strength is calculated according to ACI 318 Chapters 10 and 22 using the Load and Resistance Factored Design (LRFD) methodology. The design strength, ϕM_n , is also converted to the allowable bending strength format using the conversion factor $\alpha = 1/1.6 = 0.625$. The maximum reinforcement ratio limit, ρ_{max} , is set so that the tension strain, ϵ_t , in the tension rebar is 0.005 or greater to ensure that the strength reduction factor, ϕ , of 0.90 is adequate. The contribution of the compression rebar is ignored as there are no lateral ties to ensure that compression rebar will not buckle outward, spalling off the outer concrete. The calculations are completed in Microsoft Excel (2016) using the listed equations.

GOVERNING CODE:

Building Code Requirements for Structural Concrete, ACI 318

GOVERNING EQUATIONS:

Design Bending Strength	$\phi M_n = \phi A_s f_y (d-a/2)$	
Depth of Rectangular Stress Block	$a = A_s f_y / (0.85 f_c b)$	
Strength Reduction Factor	$\phi = 0.90$	(ACI 318, Table 21.2.2, $\epsilon_t \geq 0.005$)
Maximum reinforcement ratio	$\rho_{max} = 0.85 \beta_1 (F_c / f_y) [0.003 / (0.003 + 0.005)]$	($\beta_1 = 0.65$ for $f_c \geq 8000$ psi)
Minimum reinforcement	$A_{s,min} = 3 \sqrt{f_c} b d / f_y$	
LRFD to ASD Conversion Factor	$\alpha = 1/1.6 = 0.625$	
Concrete comp. strength	10000 psi	
Steel yield strength	60000 psi	

CALCULATIONS:

TABLE 2A: DESIGN AND ALLOWABLE BENDING STRENGTH OF CONCRETE PERMA-COLUMN ABOUT Z-AXIS

Model ID	Width (in)	Depth (in)	Reinforcement (tension rebar)	A_s (in ²)	$A_{s,max}$ (in ²)	$A_{s,min}$ (in ²)	a (in)	d (in)	ϕ	LRFD ϕM_{n-z} (ft-lb)	α	ASD M_{all-z} (ft-lb)
PC4600	4.50	5.44	(2) #4 Rebar	0.40	0.61	0.09	0.63	3.94	0.90	6527	0.625	4080
PC6300	5.38	5.44	(2) #4 Rebar	0.40	0.73	0.11	0.52	3.94	0.90	6620	0.625	4137
PC6400	6.88	5.44	(2) #4 Rebar	0.40	0.94	0.14	0.41	3.94	0.90	6723	0.625	4202
PC6600	6.38	5.44	(2) #4 Rebar	0.40	0.87	0.13	0.44	3.94	0.90	6694	0.625	4184
PC8300	5.38	7.19	(2) #5 Rebar	0.62	1.04	0.15	0.81	5.62	0.90	14545	0.625	9091
PC8400	6.88	7.19	(2) #5 Rebar	0.62	1.34	0.19	0.64	5.62	0.90	14792	0.625	9245
PC8500	8.31	7.19	(2) #5 Rebar	0.62	1.61	0.23	0.53	5.62	0.90	14945	0.625	9341

TABLE 2B: DESIGN AND ALLOWABLE BENDING STRENGTH OF CONCRETE PERMA-COLUMN ABOUT X-AXIS

Model ID	Width (in)	Depth (in)	Reinforcement (tension rebar)	A_s (in ²)	$A_{s,max}$ (in ²)	$A_{s,min}$ (in ²)	a (in)	d (in)	ϕ	LRFD ϕM_{n-x} (ft-lb)	α	ASD M_{all-x} (ft-lb)
PC4600	5.44	4.50	(2) #4 Rebar	0.40	0.56	0.08	0.52	3.00	0.90	4933	0.625	3083
PC6300	5.44	5.38	(2) #4 Rebar	0.40	0.73	0.11	0.52	3.88	0.90	6517	0.625	4073
PC6400	5.44	6.88	(2) #4 Rebar	0.40	1.01	0.15	0.52	5.38	0.90	9217	0.625	5761
PC6600	5.44	6.38	(2) #4 Rebar	0.40	0.92	0.13	0.52	4.88	0.90	8317	0.625	5198
PC8300	7.19	5.38	(2) #5 Rebar	0.62	0.95	0.14	0.61	3.81	0.90	9781	0.625	6113
PC8400	7.19	6.88	(2) #5 Rebar	0.62	1.32	0.19	0.61	5.31	0.90	13966	0.625	8729
PC8500	7.19	8.31	(2) #5 Rebar	0.62	1.67	0.24	0.61	6.74	0.90	17955	0.625	11222

ϕM_{n-x} = Design bending strength (LRFD) about the x-axis
 ϕM_{n-z} = Design bending strength (LRFD) about the z-axis
 M_{all-x} = Allowable bending strength (ASD) about the x-axis
 M_{all-z} = Allowable bending strength (ASD) about the z-axis

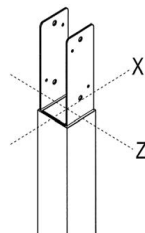

3. PERMA-COLUMN: AXIAL AND BENDING STRENGTH UNDER COMBINED LOADING

This section of the calculations describes the behavior of the Perma-Column reinforced concrete column subjected to combined axial and bending loading. The balanced failure occurs when the tension steel just begins to yield ($\epsilon_s = 0.002$) as the concrete reaches its limiting strain ϵ_u of 0.003. This condition is highlighted in the calculations tables. The strength interaction diagram is presented below each calculations table. The axial design strength is limited by expression $\phi P_n = \phi 0.60[0.85f_c'(A_g - A_s) + f_y A_s]$ which has a conservative 0.60 multiplier due to the absence of lateral ties as discussed in earlier section. This limitation is represented by a flat line in the strength interaction diagram. The axial compression calculations are based on four rebar, while the bending calculations ignore the compression rebar as discussed in section 2. As expected, when the compression axial load is increased, the design bending moment strength is also increased until the point where this trend is reversed. The lower part of the interaction diagram, however, deviates from the curve trajectory above because of the variation in the bending strength reduction factor ϕ which ranges from 0.65 to 0.90 in the lower region (upper regions is constant at $\phi = 0.65$). The calculations are completed in Microsoft Excel (2016) using the listed equations.

Because of the 0.60 multiplier that severely limits the design axial strength, the design bending strength under the combined loading is never less than the design bending strength without the axial loads as is shown in the strength interaction diagram. It is, therefore, concluded that, whether the column is subjected to singular or combined bending and axial compression loads, the individual factored axial and bending forces should not exceed the design axial compression and bending strengths as determined by the singular load analyses in previous sections.

GOVERNING CODE:

Building Code Requirements for Structural Concrete, ACI 318

GOVERNING EQUATIONS:

Design Bending Strength	$\phi M_n = \phi A_s f_y (d - a/2)$	(pure bending)
Design Axial Strength	$\phi P_n = \phi 0.60[0.85f_c'(A_g - A_s) + f_y A_s]$	(pure axial)
Design Axial and Bending Strength under Combined Loading	$\phi M_n = \phi[0.85f_c'ab(h/2 - a/2) + A_s f_s(d - h/2)]$	
	$\phi P_n = \phi[0.85f_c'ab + A_s f_s - A_s f_s] \leq \phi P_n = \phi 0.60[0.85f_c'(A_g - A_s) + f_y A_s]$	

- Depth of Rectangular Stress Block $a = c\beta_1 \leq h$, where c = distance to the elastic neutral axis (NA)
- Strain in rebar $\epsilon_s = \epsilon (d - c) / c$
- Distance to N/A for balanced failure $c_b = d\epsilon_u / (\epsilon_u + \epsilon_y)$, where $\epsilon_y = f_y/E$
- Stress in rebar $f_s = \epsilon_u E_s (d - c) / c \leq f_y$
- Concrete Compressive Resultant $C = 0.85f_c'ab$

CALCULATIONS FOR PC4600

β_1	0.65	
Steel Yield Strength, F_y	60000	psi
Concrete comp. strength, f_c	10000	psi
Column Depth, h	5.44	in
Column Width, b	4.50	in
Dimension d to tension rebar	3.94	in
Dimension d' to compression rebar	1.50	in
Diameter of longitudinal rebar	0.5	in

TABLE 3A: STRENGTH INTERACTION CHART

c	a	A_s	f_s	A_s'	f_s'	$0.85f_c'ab$	$A_s f_s$	$A_s' f_s'$	ϕ_a	ϕP_n^*	ϕP_n	ϕ_b	ϕM_n
(in)	(in)	(in ²)	(psi)	(in ²)	(psi)	(lb)	(lb)	(lb)		(lb)	(lb)		(ft-lb)
0.009	0.97	0.63	0.40	-	0.40	-	24000	0	0.65		0	0.90	6527
0.008	1.10	0.72	0.40	60000	0.40	-31425	27398	24000	0.65		2208	0.90	7049
0.007	1.24	0.81	0.40	60000	0.40	-18360	30795	24000	0.65		4417	0.90	7548
0.006	1.38	0.89	0.40	60000	0.40	-7891	34193	24000	0.65		6625	0.90	8025
0.005	1.51	0.98	0.40	60000	0.40	686	37590	24000	0.65		9012	0.88	8336
0.004	1.65	1.07	0.40	60000	0.40	7841	40988	24000	0.65		13081	0.83	8226
0.004	1.79	1.16	0.40	60000	0.40	13900	44385	24000	0.65		16864	0.79	8129
0.003	1.92	1.25	0.40	60000	0.40	19098	47783	24000	0.65		20424	0.75	8043
0.003	2.06	1.34	0.40	60000	0.40	23605	51180	24000	0.65		23805	0.71	7964
0.002	2.20	1.43	0.40	60000	0.40	27552	54578	24000	0.65		27039	0.68	7889
0.002	2.33	1.52	0.40	60000	0.40	31036	57975	24000	0.65		30153	0.65	7748
0.002	2.62	1.70	0.40	44070	0.40	37100	65022	17628	0.65		40452	0.65	7751
0.001	2.90	1.88	0.40	31255	0.40	41979	72068	12502	0.65		49632	0.65	7767
0.001	3.18	2.07	0.40	20723	0.40	45989	79114	8289	0.65		57993	0.65	7772
0.000	3.47	2.25	0.40	11913	0.40	49343	86160	4765	0.65		65736	0.65	7753
0.000	3.75	2.44	0.40	4435	0.40	52190	93206	1774	0.65		73000	0.65	7698
	4.03	2.62	0.40	-1991	0.40	54636	100253	-796	0.65		79887	0.65	7601
	4.32	2.81	0.40	-7574	0.40	56762	107299	-3029	0.65		86471	0.65	7457
	4.60	2.99	0.40	-12468	0.40	58625	114345	-4987	0.65		92809	0.65	7260
	4.88	3.17	0.40	-16794	0.40	60000	121391	-6718	0.65	98871	98871	0.65	7007
	5.17	3.36	0.40	-20646	0.40	60000	128438	-8258	0.65	104452	104452	0.65	6697
	5.45	3.54	0.40	-24097	0.40	60000	135484	-9639	0.65	109930	109930	0.65	6327
	5.73	3.73	0.40	-27207	0.40	60000	142530	-10883	0.65	115318	113100	0.65	5896
	6.02	3.91	0.40	-30023	0.40	60000	149576	-12009	0.65	120631	113100	0.65	5402
	6.30	4.09	0.40	-32587	0.40	60000	156623	-13035	0.65	125877	113100	0.65	4845
	6.58	4.28	0.40	-34929	0.40	60000	163669	-13972	0.65	131066	113100	0.65	4223
	6.87	4.46	0.40	-37078	0.40	60000	170715	-14831	0.65	136205	113100	0.65	3536
	7.15	4.65	0.40	-39057	0.40	60000	177761	-15623	0.65	141300	113100	0.65	2784
	7.43	4.83	0.40	-40885	0.40	60000	184808	-16354	0.65	146355	113100	0.65	1965
	7.72	5.02	0.40	-42579	0.40	60000	191854	-17032	0.65	151375	113100	0.65	1079
	8.00	5.20	0.40	-44153	0.40	60000	198900	-17661	0.65	156365	113100	0.65	126
	∞								0.65	188500	113100		0

* The values in this column show what the Design Axial Strength would have been without the 0.60 multiplier

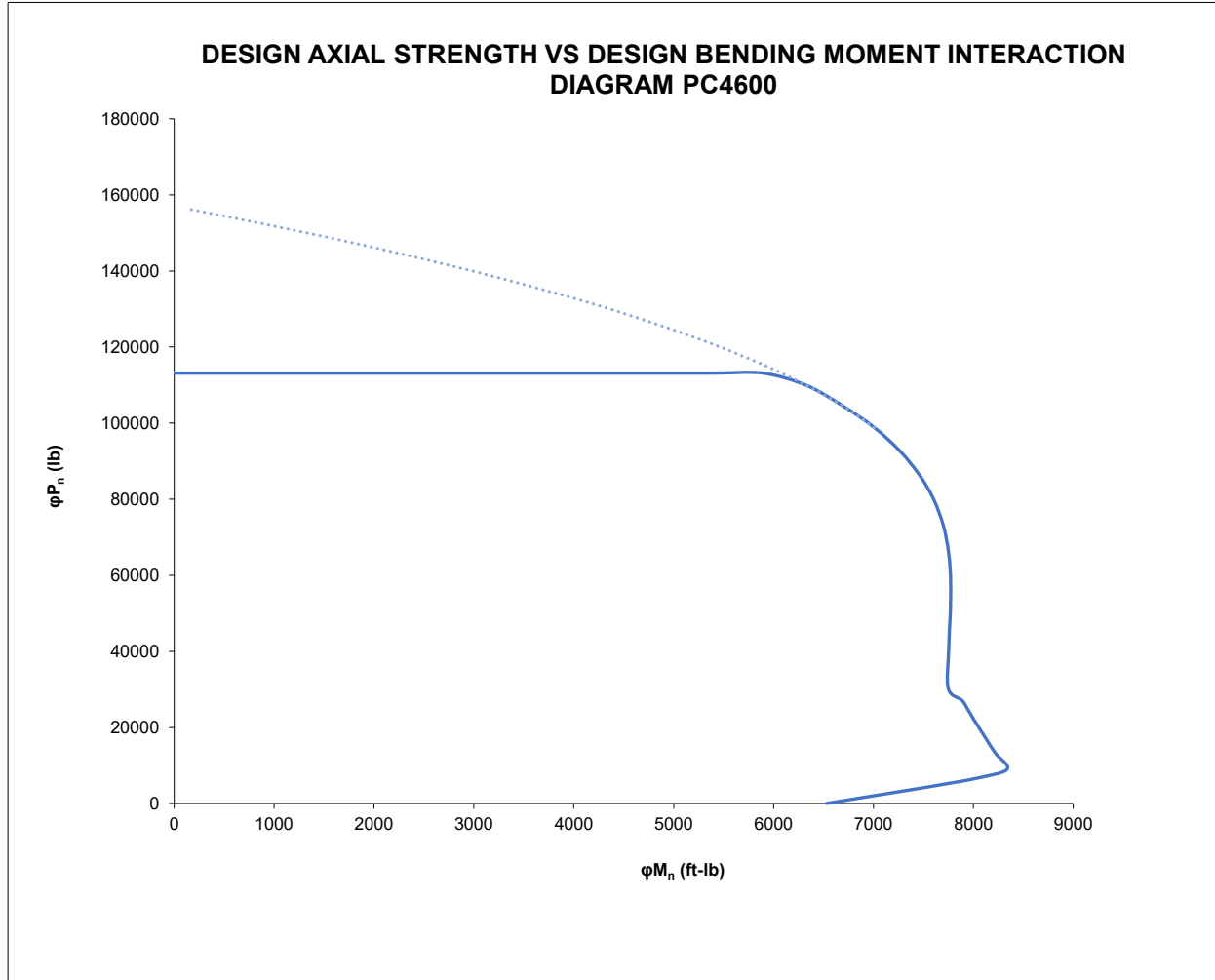

CALCULATIONS FOR PC6300

β_1	0.65	
Steel Yield Strength, F_y	60000	psi
Concrete comp. strength, f_c	10000	psi
Column Depth, h	5.44	in
Column Width, b	5.38	in
Dimension d to tension rebar	3.94	in
Dimension d' to compression rebar	1.50	in
Diameter of longitudinal rebar	0.5	in

TABLE 3B: STRENGTH INTERACTION CHART

c	a	A_s	f_s	A_s'	f_s'	$0.85f_c'ab$	$A_s f_s$	$A_s' f_s'$	ϕ_a	ϕP_n^*	ϕP_n	ϕ_b	ϕM_n
(in)	(in)	(in ²)	(psi)	(in ²)	(psi)	(lb)	(lb)	(lb)		(lb)	(lb)		(ft-lb)
0.012	0.81	0.52	0.40	-	0.40	-	24000	0	0.65		0	0.90	6620
0.009	0.96	0.62	0.40	60000	0.40	-48958	28531	24000	0.65		2945	0.90	7349
0.008	1.11	0.72	0.40	60000	0.40	-30325	33063	24000	0.65		5891	0.90	8044
0.006	1.26	0.82	0.40	60000	0.40	-16183	37594	24000	0.65		8836	0.90	8706
0.005	1.42	0.92	0.40	60000	0.40	-5084	42125	24000	0.65		11781	0.90	9334
0.005	1.57	1.02	0.40	60000	0.40	3859	46656	24000	0.65	1544	15730	0.86	9497
0.004	1.72	1.12	0.40	60000	0.40	11219	51188	24000	0.65	4488	20589	0.81	9386
0.003	1.87	1.22	0.40	60000	0.40	17382	55719	24000	0.65	6953	25137	0.76	9288
0.003	2.03	1.32	0.40	60000	0.40	22618	60250	24000	0.65	9047	29443	0.72	9199
0.002	2.18	1.42	0.40	60000	0.40	27121	64781	24000	0.65	10848	33559	0.69	9114
0.002	2.33	1.52	0.40	60000	0.40	31036	69313	24000	0.65	12414	37522	0.65	8953
0.002	2.62	1.70	0.40	44070	0.40	37100	77737	17628	0.65	14840	48717	0.65	9039
0.001	2.90	1.88	0.40	31255	0.40	41979	86161	12502	0.65	16792	58793	0.65	9124
0.001	3.18	2.07	0.40	20723	0.40	45989	94585	8289	0.65	18396	68050	0.65	9185
0.000	3.47	2.25	0.40	11913	0.40	49343	103009	4765	0.65	19737	76688	0.65	9207
0.000	3.75	2.44	0.40	4435	0.40	52190	111434	1774	0.65	20876	84848	0.65	9181
	4.03	2.62	0.40	-1991	0.40	54636	119858	-796	0.65	21854	92631	0.65	9098
	4.32	2.81	0.40	-7574	0.40	56762	128282	-3029	0.65	22705	100110	0.65	8954
	4.60	2.99	0.40	-12468	0.40	58625	136706	-4987	0.65	23450	107343	0.65	8744
	4.88	3.17	0.40	-16794	0.40	60000	145130	-6718	0.65	24000	114301	0.65	8464
	5.17	3.36	0.40	-20646	0.40	60000	153554	-8258	0.65	24000	120778	0.65	8113
	5.45	3.54	0.40	-24097	0.40	60000	161979	-9639	0.65	24000	127151	0.65	7689
	5.73	3.73	0.40	-27207	0.40	60000	170403	-10883	0.65	24000	133435	0.65	7190
	6.02	3.91	0.40	-30023	0.40	60000	178827	-12009	0.65	24000	139644	0.65	6614
	6.30	4.09	0.40	-32587	0.40	60000	187251	-13035	0.65	24000	145786	0.65	5961
	6.58	4.28	0.40	-34929	0.40	60000	195675	-13972	0.65	24000	151870	0.65	5230
	6.87	4.46	0.40	-37078	0.40	60000	204099	-14831	0.65	24000	157905	0.65	4420
	7.15	4.65	0.40	-39057	0.40	60000	212524	-15623	0.65	24000	163895	0.65	3530
	7.43	4.83	0.40	-40885	0.40	60000	220948	-16354	0.65	24000	169846	0.65	2560
	7.72	5.02	0.40	-42579	0.40	60000	229372	-17032	0.65	24000	175762	0.65	1510
	8.00	5.20	0.40	-44153	0.40	60000	237796	-17661	0.65	24000	181647	0.65	379
	∞								0.65	188500	113100		0

* The values in this column show what the Design Axial Strength would have been without the 0.60 multiplier

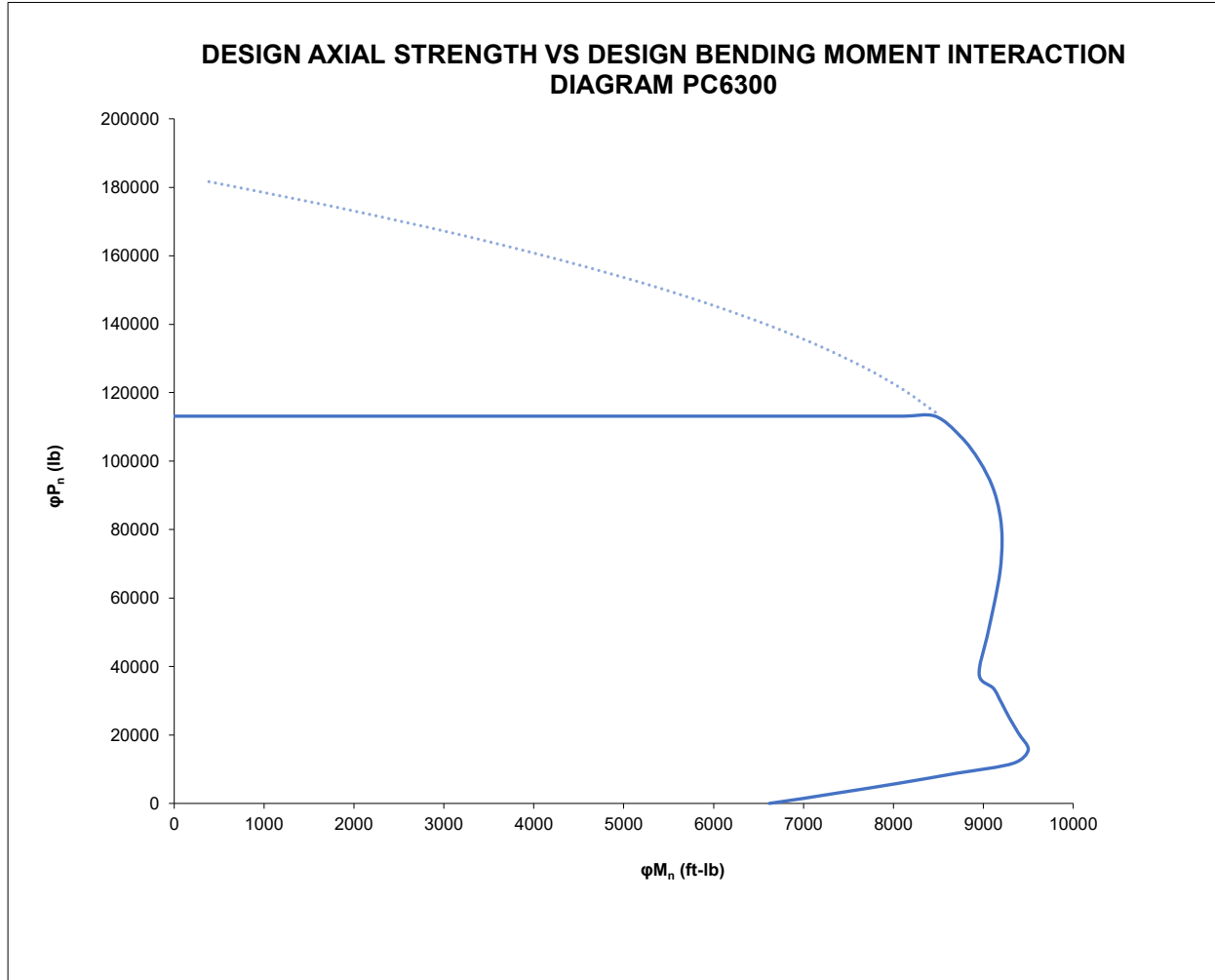

CALCULATIONS FOR PC6400

β_1	0.65	
Steel Yield Strength, F_y	60000	psi
Concrete comp. strength, f_c	10000	psi
Column Depth, h	5.44	in
Column Width, b	6.88	in
Dimension d to tension rebar	3.94	in
Dimension d' to compression rebar	1.50	in
Diameter of longitudinal rebar	0.5	in

TABLE 3C: STRENGTH INTERACTION CHART

c	a	A_s	f_s	A_s'	f_s'	$0.85f_c'ab$	$A_s f_s$	$A_s' f_s'$	ϕ_a	ϕP_n^*	ϕP_n	ϕ_b	ϕM_n
(in)	(in)	(in ²)	(psi)	(in ²)	(psi)	(lb)	(lb)	(lb)		(lb)	(lb)		(ft-lb)
0.016	0.63	0.40	-	0.40	-	-	24000	0	0.65		0	0.90	6723
0.012	0.80	0.40	60000	0.40	-75835	30464	24000	0	0.65		4201	0.90	7816
0.009	0.97	0.40	60000	0.40	-47332	36928	24000	0	0.65		8403	0.90	8855
0.007	1.14	0.40	60000	0.40	-27322	43391	24000	0	0.65		12604	0.90	9840
0.006	1.31	0.40	60000	0.40	-12500	49855	24000	0	0.65		16806	0.90	10773
0.005	1.48	0.40	60000	0.40	-1080	56319	24000	0	0.65		21007	0.90	11627
0.004	1.65	0.40	60000	0.40	7988	62783	24000	3195	0.65		27286	0.83	11502
0.003	1.82	0.40	60000	0.40	15364	69246	24000	6145	0.65		33405	0.77	11393
0.003	1.99	0.40	60000	0.40	21480	75710	24000	8592	0.65		39196	0.73	11294
0.002	2.16	0.40	60000	0.40	26633	82174	24000	10653	0.65		44738	0.69	11199
0.002	2.33	0.40	60000	0.40	31036	88638	24000	12414	0.65		50084	0.65	11007
0.002	2.62	0.40	44070	0.40	37100	99411	17628	14840	0.65		62805	0.65	11235
0.001	2.90	0.40	31255	0.40	41979	110184	12502	16792	0.65		74408	0.65	11437
0.001	3.18	0.40	20723	0.40	45989	120957	8289	18396	0.65		85191	0.65	11593
0.000	3.47	0.40	11913	0.40	49343	131729	4765	19737	0.65		95356	0.65	11687
0.000	3.75	0.40	4435	0.40	52190	142502	1774	20876	0.65		105043	0.65	11708
	4.03	0.40	-1991	0.40	54636	153275	-796	21854	0.65		114352	0.65	11650
	4.32	0.40	-7574	0.40	56762	164048	-3029	22705	0.65		123358	0.65	11506
	4.60	0.40	-12468	0.40	58625	174821	-4987	23450	0.65		132118	0.65	11273
	4.88	0.40	-16794	0.40	60000	185594	-6718	24000	0.65	140603	140100	0.65	10948
	5.17	0.40	-20646	0.40	60000	196367	-8258	24000	0.65	148606	140100	0.65	10528
	5.45	0.40	-24097	0.40	60000	207140	-9639	24000	0.65	156506	140100	0.65	10011
	5.73	0.40	-27207	0.40	60000	217913	-10883	24000	0.65	164317	140100	0.65	9395
	6.02	0.40	-30023	0.40	60000	228686	-12009	24000	0.65	172052	140100	0.65	8679
	6.30	0.40	-32587	0.40	60000	239459	-13035	24000	0.65	179721	140100	0.65	7863
	6.58	0.40	-34929	0.40	60000	250231	-13972	24000	0.65	187332	140100	0.65	6945
	6.87	0.40	-37078	0.40	60000	261004	-14831	24000	0.65	194893	140100	0.65	5925
	7.15	0.40	-39057	0.40	60000	271777	-15623	24000	0.65	202410	140100	0.65	4802
	7.43	0.40	-40885	0.40	60000	282550	-16354	24000	0.65	209888	140100	0.65	3575
	7.72	0.40	-42579	0.40	60000	293323	-17032	24000	0.65	217331	140100	0.65	2245
	8.00	0.40	-44153	0.40	60000	304096	-17661	24000	0.65	224742	140100	0.65	810
∞									0.65	233500	140100		0

* The values in this column show what the Design Axial Strength would have been without the 0.60 multiplier

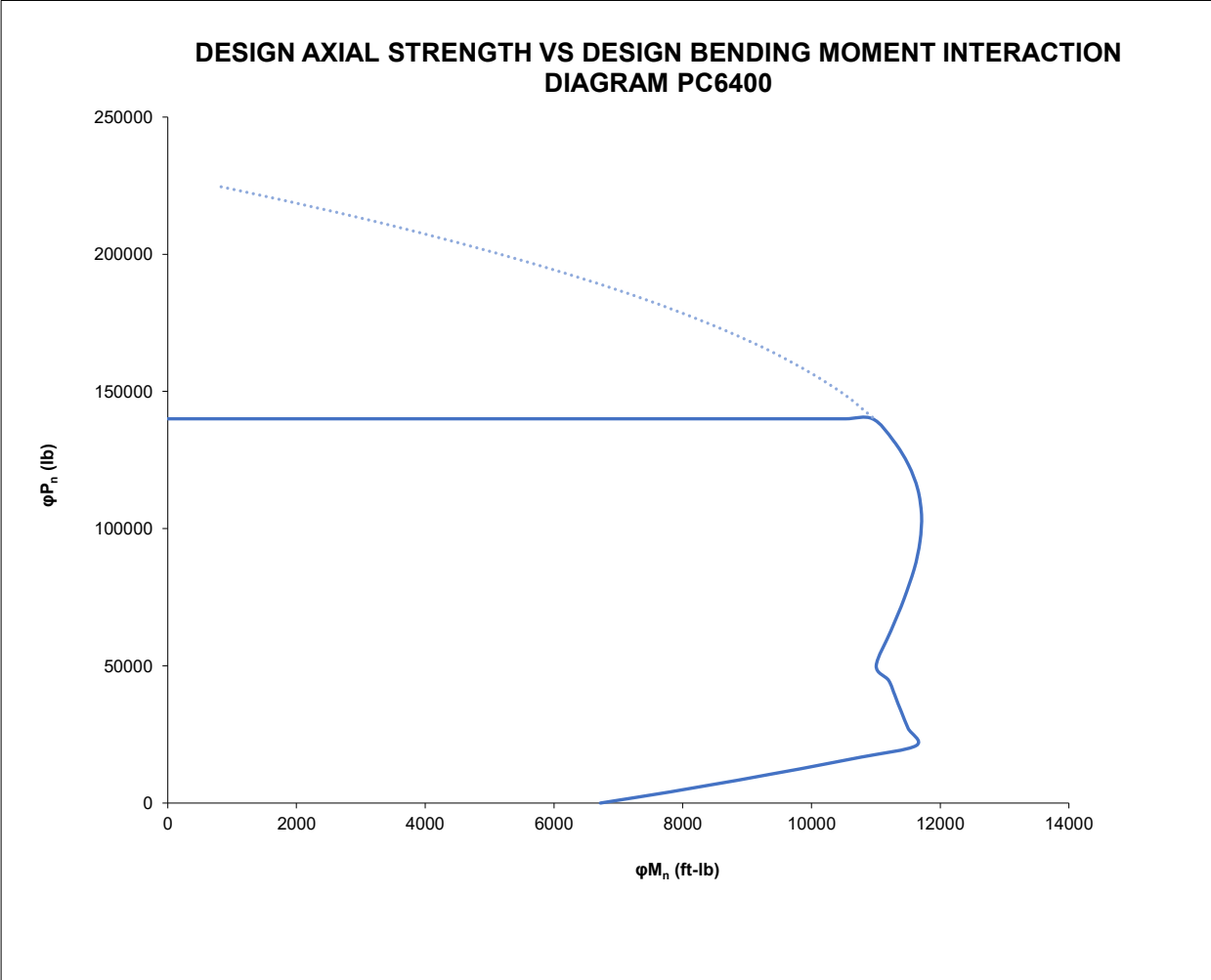

CALCULATIONS FOR PC6600

β_1	0.65	
Steel Yield Strength, F_y	60000	psi
Concrete comp. strength, f_c	10000	psi
Column Depth, h	5.44	in
Column Width, b	6.38	in
Dimension d to tension rebar	3.94	in
Dimension d' to compression rebar	1.50	in
Diameter of longitudinal rebar	0.5	in

TABLE 3D: STRENGTH INTERACTION CHART

c	a	A_s	f_s	A_s'	f_s'	$0.85f_c'ab$	$A_s f_s$	$A_s' f_s'$	ϕ_a	ϕP_n^*	ϕP_n	ϕ_b	ϕM_n
(in)	(in)	(in ²)	(psi)	(in ²)	(psi)	(lb)	(lb)	(lb)		(lb)	(lb)		(ft-lb)
0.014	0.68	0.40	-	0.40	-	-	24000	0	0.65		0	0.90	6694
0.011	0.85	0.40	60000	0.40	-67263	29820	24000	0	0.65		3783	0.90	7664
0.009	1.01	0.40	60000	0.40	-42073	35639	24000	0	0.65		7565	0.90	8588
0.007	1.18	0.40	60000	0.40	-23955	41459	24000	0	0.65		11348	0.90	9465
0.006	1.34	0.40	60000	0.40	-10297	47278	24000	0	0.65		15131	0.90	10295
0.005	1.51	0.40	60000	0.40	367	53098	24000	147	0.65		19009	0.89	10921
0.004	1.67	0.40	60000	0.40	8924	58918	24000	3570	0.65		25017	0.82	10799
0.003	1.84	0.40	60000	0.40	15943	64737	24000	6377	0.65		30624	0.77	10694
0.003	2.00	0.40	60000	0.40	21804	70557	24000	8721	0.65		35931	0.73	10597
0.002	2.17	0.40	60000	0.40	26771	76376	24000	10708	0.65		41005	0.69	10505
0.002	2.33	0.40	60000	0.40	31036	82196	24000	12414	0.65		45897	0.65	10322
0.002	2.62	0.40	44070	0.40	37100	92186	17628	14840	0.65		58109	0.65	10503
0.001	2.90	0.40	31255	0.40	41979	102176	12502	16792	0.65		69203	0.65	10666
0.001	3.18	0.40	20723	0.40	45989	112166	8289	18396	0.65		79477	0.65	10790
0.000	3.47	0.40	11913	0.40	49343	122156	4765	19737	0.65		89133	0.65	10860
0.000	3.75	0.40	4435	0.40	52190	132146	1774	20876	0.65		98311	0.65	10866
	4.03	0.40	-1991	0.40	54636	142136	-796	21854	0.65		107112	0.65	10799
	4.32	0.40	-7574	0.40	56762	152126	-3029	22705	0.65		115609	0.65	10655
	4.60	0.40	-12468	0.40	58625	162116	-4987	23450	0.65		123860	0.65	10430
	4.88	0.40	-16794	0.40	60000	172106	-6718	24000	0.65	131835	131100	0.65	10120
	5.17	0.40	-20646	0.40	60000	182096	-8258	24000	0.65	139330	131100	0.65	9723
	5.45	0.40	-24097	0.40	60000	192086	-9639	24000	0.65	146721	131100	0.65	9237
	5.73	0.40	-27207	0.40	60000	202076	-10883	24000	0.65	154023	131100	0.65	8660
	6.02	0.40	-30023	0.40	60000	212066	-12009	24000	0.65	161249	131100	0.65	7991
	6.30	0.40	-32587	0.40	60000	222056	-13035	24000	0.65	168409	131100	0.65	7229
	6.58	0.40	-34929	0.40	60000	232046	-13972	24000	0.65	175512	131100	0.65	6374
	6.87	0.40	-37078	0.40	60000	242036	-14831	24000	0.65	182564	131100	0.65	5423
	7.15	0.40	-39057	0.40	60000	252026	-15623	24000	0.65	189572	131100	0.65	4378
	7.43	0.40	-40885	0.40	60000	262016	-16354	24000	0.65	196541	131100	0.65	3237
	7.72	0.40	-42579	0.40	60000	272006	-17032	24000	0.65	203474	131100	0.65	2000
	8.00	0.40	-44153	0.40	60000	281996	-17661	24000	0.65	210377	131100	0.65	666
∞									0.65	218500	131100		0

* The values in this column show what the Design Axial Strength would have been without the 0.60 multiplier

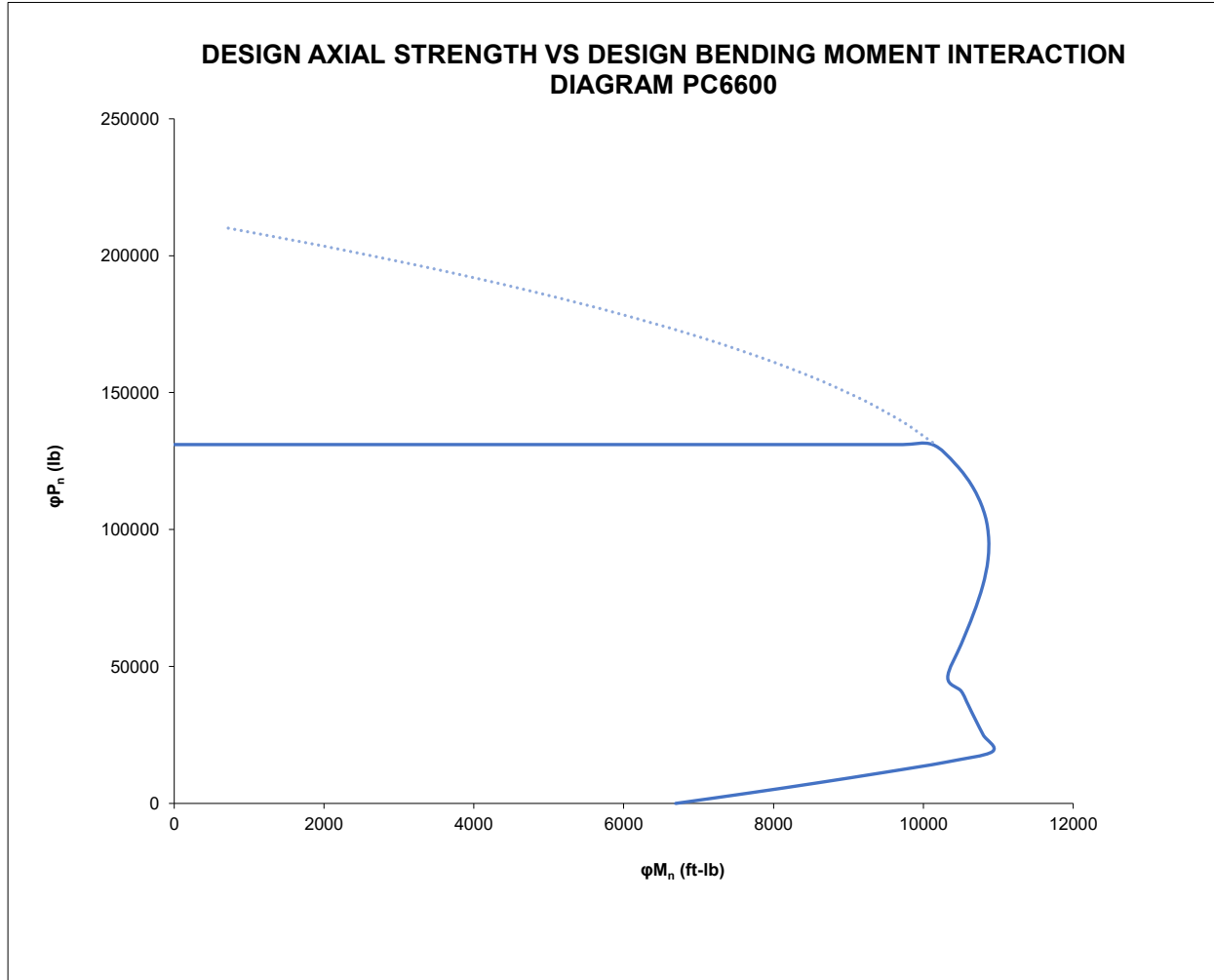

CALCULATIONS FOR PC8300

β_1	0.65	
Steel Yield Strength, F_y	60000	psi
Concrete comp. strength, f_c	10000	psi
Column Depth, h	7.19	in
Column Width, b	5.38	in
Dimension d to tension rebar	5.62	in
Dimension d' to compression rebar	1.56	in
Diameter of longitudinal rebar	0.625	in

TABLE 3E: STRENGTH INTERACTION CHART

c	a	A_s	f_s	A_s'	f_s'	$0.85f_c'ab$	$A_s f_s$	$A_s' f_s'$	ϕ_a	ϕP_n^*	ϕP_n	ϕ_b	ϕM_n
(in)	(in)	(in ²)	(psi)	(in ²)	(psi)	(lb)	(lb)	(lb)		(lb)	(lb)		(ft-lb)
0.010	1.25	0.81	0.62	-	0.62	-	37200		0.65		0	0.90	14545
0.009	1.46	0.95	0.62	60000	0.62	-6025	43367	37200	0.65		4008	0.90	15800
0.007	1.67	1.08	0.62	60000	0.62	5556	49533	37200	0.65		10256	0.90	16993
0.006	1.87	1.22	0.62	60000	0.62	14573	55700	37200	0.65		17898	0.90	18124
0.005	2.08	1.35	0.62	60000	0.62	21792	61867	37200	0.65		24816	0.90	19192
0.004	2.29	1.49	0.62	60000	0.62	27703	68034	37200	0.65		31206	0.85	19013
0.004	2.50	1.62	0.62	60000	0.62	32631	74200	37200	0.65		37201	0.80	18702
0.003	2.70	1.76	0.62	60000	0.62	36803	80367	37200	0.65		42890	0.75	18425
0.003	2.91	1.89	0.62	60000	0.62	40380	86534	37200	0.65		48340	0.72	18170
0.002	3.12	2.03	0.62	60000	0.62	43481	92701	37200	0.65		53598	0.68	17930
0.002	3.33	2.16	0.62	60000	0.62	46196	98867	37200	0.65		58701	0.65	17544
0.002	3.69	2.40	0.62	45601	0.62	50193	109604	28272	0.65		73093	0.65	17330
0.001	4.05	2.63	0.62	33770	0.62	53477	120340	20938	0.65		86163	0.65	17154
0.001	4.41	2.87	0.62	23878	0.62	56222	131076	14804	0.65		98234	0.65	16973
0.001	4.77	3.10	0.62	15484	0.62	58553	141813	9600	0.65		109535	0.65	16758
0.000	5.13	3.34	0.62	8271	0.62	60000	152549	5128	0.65		120004	0.65	16486
0.000	5.49	3.57	0.62	2007	0.62	60000	163285	1244	0.65		129507	0.65	16142
	5.85	3.81	0.62	-3484	0.62	60000	174021	-2160	0.65		138698	0.65	15715
	6.22	4.04	0.62	-8338	0.62	60000	184758	-5169	0.65		147633	0.65	15194
	6.58	4.27	0.62	-12658	0.62	60000	195494	-7848	0.65	156352	153100	0.65	14573
	6.94	4.51	0.62	-16528	0.62	60000	206230	-10247	0.65	164890	153100	0.65	13846
	7.30	4.74	0.62	-20015	0.62	60000	216967	-12409	0.65	173274	153100	0.65	13009
	7.66	4.98	0.62	-23173	0.62	60000	227703	-14368	0.65	181526	153100	0.65	12057
	8.02	5.21	0.62	-26047	0.62	60000	238439	-16149	0.65	189663	153100	0.65	10989
	8.38	5.45	0.62	-28674	0.62	60000	249176	-17778	0.65	197700	153100	0.65	9800
	8.74	5.68	0.62	-31083	0.62	60000	259912	-19271	0.65	205649	153100	0.65	8490
	9.11	5.92	0.62	-33301	0.62	60000	270648	-20647	0.65	213522	153100	0.65	7056
	9.47	6.15	0.62	-35350	0.62	60000	281385	-21917	0.65	221326	153100	0.65	5497
	9.83	6.39	0.62	-37248	0.62	60000	292121	-23094	0.65	229070	153100	0.65	3812
	10.19	6.62	0.62	-39012	0.62	60000	302857	-24187	0.65	236759	153100	0.65	2000
	10.55	6.86	0.62	-40655	0.62	60000	313593	-25206	0.65	244400	153100	0.65	59
	∞								0.65	255167	153100		0

* The values in this column show what the Design Axial Strength would have been without the 0.60 multiplier

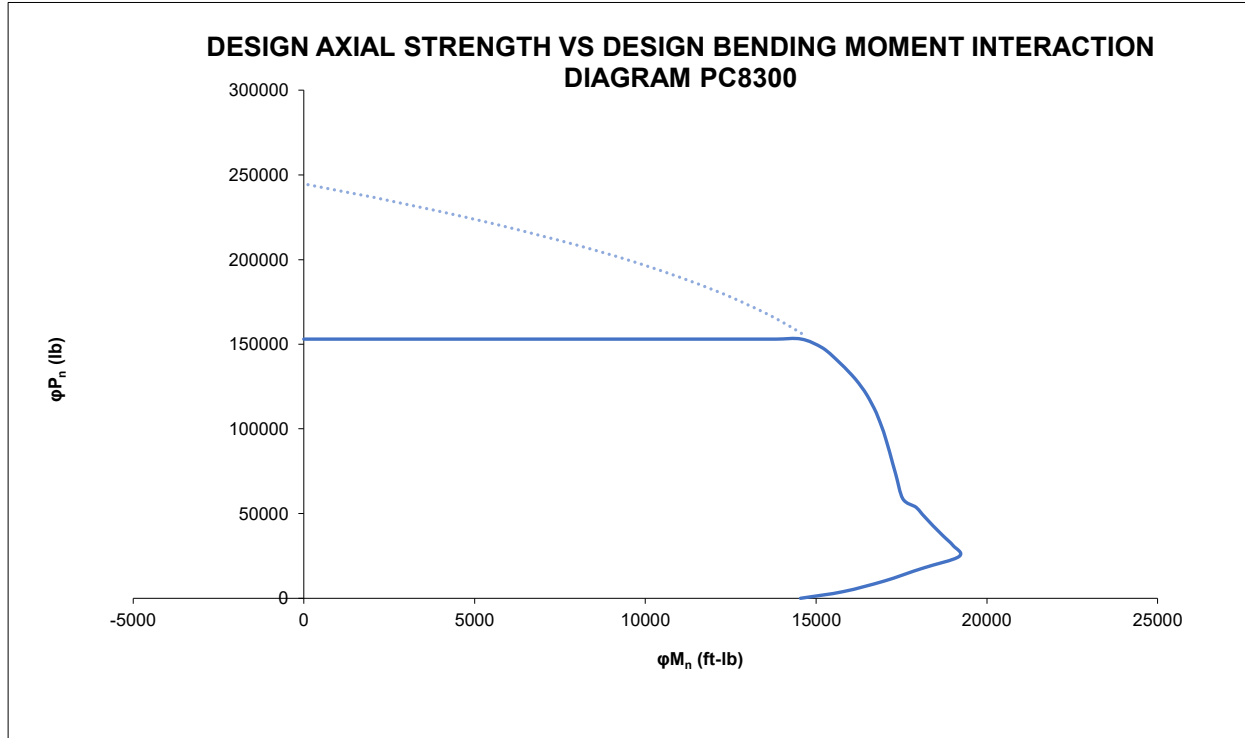

CALCULATIONS FOR PC8400

β_1	0.65	
Steel Yield Strength, F_y	60000	psi
Concrete comp. strength, f_c	10000	psi
Column Depth, h	7.19	in
Column Width, b	6.88	in
Dimension d to tension rebar	5.62	in
Dimension d' to compression rebar	1.56	in
Diameter of longitudinal rebar	0.625	in

TABLE 3F: STRENGTH INTERACTION CHART

c	a	A_s	f_s	A_s'	f_s'	$0.85f_c'ab$	$A_s f_s$	$A_s' f_s'$	ϕ_a	ϕP_n^*	ϕP_n	ϕ_b	ϕM_n
(in)	(in)	(in ²)	(psi)	(in ²)	(psi)	(lb)	(lb)	(lb)		(lb)	(lb)		(ft-lb)
0.014	0.98	0.64	0.62	-	0.62	-	37200	0	0.65		0	0.90	14792
0.011	1.21	0.79	0.62	60000	0.62	-24852	46123	37200	0.65		5800	0.90	16722
0.009	1.45	0.94	0.62	60000	0.62	-6721	55047	37200	0.65		11600	0.90	18549
0.007	1.68	1.09	0.62	60000	0.62	6353	63970	37200	0.65		19960	0.90	20274
0.006	1.92	1.25	0.62	60000	0.62	16225	72893	37200	0.65		29739	0.90	21896
0.005	2.15	1.40	0.62	60000	0.62	23944	81816	37200	0.65		38650	0.89	23055
0.004	2.39	1.55	0.62	60000	0.62	30145	90740	37200	0.65		46949	0.82	22681
0.003	2.62	1.70	0.62	60000	0.62	35236	99663	37200	0.65		54801	0.77	22352
0.003	2.86	1.86	0.62	60000	0.62	39489	108586	37200	0.65		62315	0.73	22050
0.002	3.09	2.01	0.62	60000	0.62	43097	117509	37200	0.65		69569	0.69	21765
0.002	3.33	2.16	0.62	60000	0.62	46196	126433	37200	0.65		76618	0.65	21297
0.002	3.69	2.40	0.62	45601	0.62	50193	140162	28272	0.65		92956	0.65	21297
0.001	4.05	2.63	0.62	33770	0.62	53477	153892	20938	0.65		107971	0.65	21296
0.001	4.41	2.87	0.62	23878	0.62	56222	167622	14804	0.65		121989	0.65	21252
0.001	4.77	3.10	0.62	15484	0.62	58553	181351	9600	0.65		135235	0.65	21136
0.000	5.13	3.34	0.62	8271	0.62	60000	195081	5128	0.65		147649	0.65	20926
0.000	5.49	3.57	0.62	2007	0.62	60000	208811	1244	0.65		159098	0.65	20605
	5.85	3.81	0.62	-3484	0.62	60000	222540	-2160	0.65		170236	0.65	20162
	6.22	4.04	0.62	-8338	0.62	60000	236270	-5169	0.65		181116	0.65	19589
	6.58	4.27	0.62	-12658	0.62	60000	250000	-7848	0.65	191781	188900	0.65	18876
	6.94	4.51	0.62	-16528	0.62	60000	263730	-10247	0.65	202265	188900	0.65	18020
	7.30	4.74	0.62	-20015	0.62	60000	277459	-12409	0.65	212595	188900	0.65	17015
	7.66	4.98	0.62	-23173	0.62	60000	291189	-14368	0.65	222792	188900	0.65	15859
	8.02	5.21	0.62	-26047	0.62	60000	304919	-16149	0.65	232874	188900	0.65	14546
	8.38	5.45	0.62	-28674	0.62	60000	318648	-17778	0.65	242857	188900	0.65	13076
	8.74	5.68	0.62	-31083	0.62	60000	332378	-19271	0.65	252752	188900	0.65	11446
	9.11	5.92	0.62	-33301	0.62	60000	346108	-20647	0.65	262570	188900	0.65	9655
	9.47	6.15	0.62	-35350	0.62	60000	359837	-21917	0.65	272320	188900	0.65	7700
	9.83	6.39	0.62	-37248	0.62	60000	373567	-23094	0.65	282010	188900	0.65	5582
	10.19	6.62	0.62	-39012	0.62	60000	387297	-24187	0.65	291645	188900	0.65	3297
	10.55	6.86	0.62	-40655	0.62	60000	401027	-25206	0.65	301231	188900	0.65	847
	∞								0.65	314833	188900		0

* The values in this column show what the Design Axial Strength would have been without the 0.60 multiplier

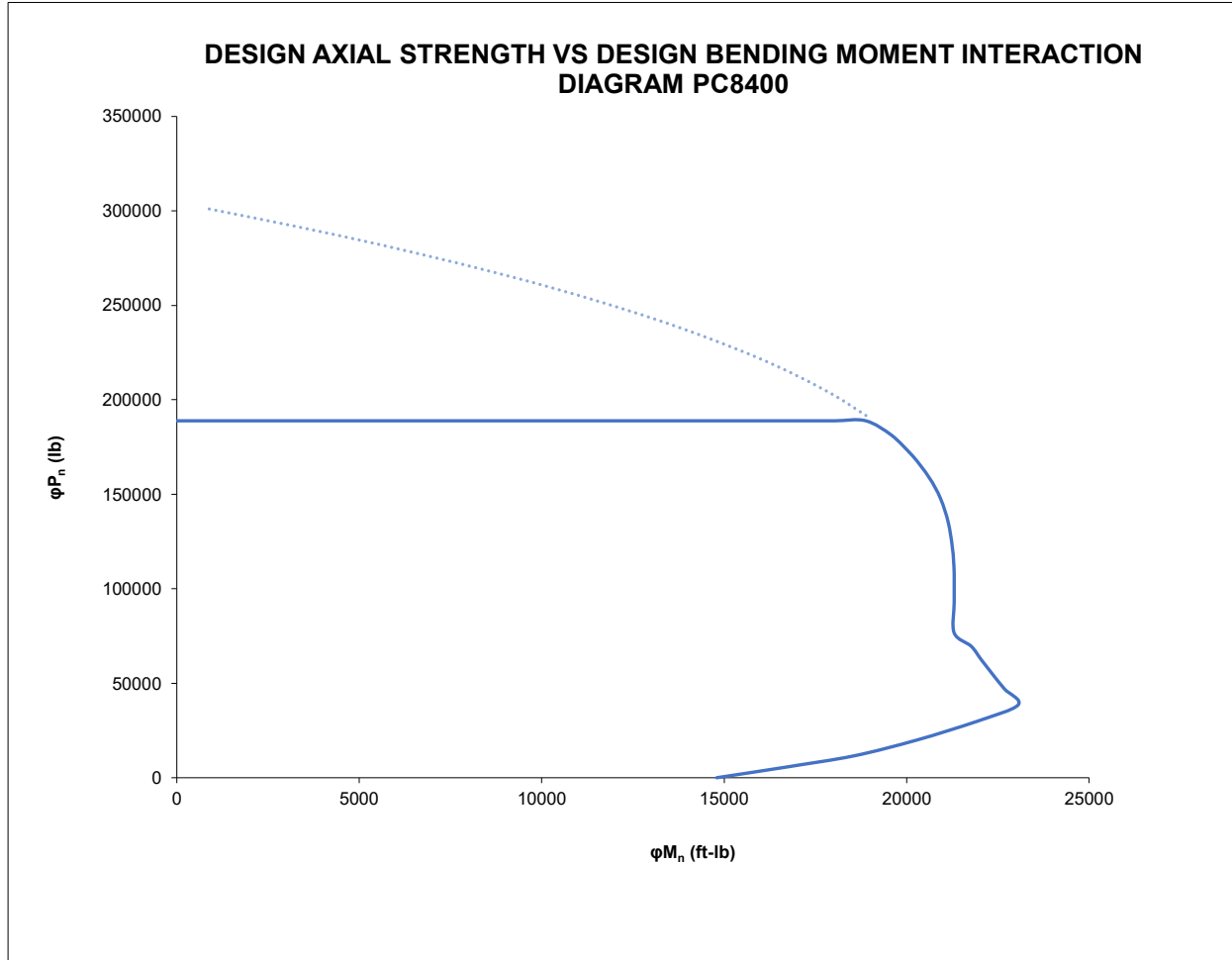

CALCULATIONS FOR PC8500

β_1	0.65	
Steel Yield Strength, F_y	60000	psi
Concrete comp. strength, f_c	10000	psi
Column Depth, h	7.19	in
Column Width, b	8.31	in
Dimension d to tension rebar	5.62	in
Dimension d' to compression rebar	1.56	in
Diameter of longitudinal rebar	0.625	in

TABLE 3G: STRENGTH INTERACTION CHART

	c	a	A_s	f_s	A_s'	f_s'	$0.85f_c'ab$	$A_s f_s$	$A_s' f_s'$	ϕ_a	ϕP_n^*	ϕP_n	ϕ_b	ϕM_n
	(in)	(in)	(in ²)	(psi)	(in ²)	(psi)	(lb)	(lb)	(lb)		(lb)	(lb)		(ft-lb)
0.018	0.81	0.53	0.62	-	0.62	-	-	37200		0.65		0	0.90	14945
0.013	1.06	0.69	0.62	60000	0.62	-40818	48751	37200	0	0.65		7508	0.90	17533
0.010	1.31	0.85	0.62	60000	0.62	-16334	60302	37200	0	0.65		15016	0.90	19978
0.008	1.56	1.02	0.62	60000	0.62	278	71853	37200	172	0.65		22637	0.90	22282
0.006	1.82	1.18	0.62	60000	0.62	12289	83405	37200	7619	0.65		34985	0.90	24445
0.005	2.07	1.34	0.62	60000	0.62	21377	94956	37200	13254	0.65		46156	0.90	26465
0.004	2.32	1.51	0.62	60000	0.62	28494	106507	37200	17666	0.65		56533	0.84	26423
0.004	2.57	1.67	0.62	60000	0.62	34218	118058	37200	21215	0.65		66348	0.78	26062
0.003	2.82	1.83	0.62	60000	0.62	38923	129609	37200	24132	0.65		75752	0.73	25730
0.002	3.07	2.00	0.62	60000	0.62	42857	141160	37200	26571	0.65		84845	0.69	25412
0.002	3.33	2.16	0.62	60000	0.62	46196	152711	37200	28641	0.65		93699	0.65	24876
0.002	3.69	2.40	0.62	45601	0.62	50193	169295	28272	31120	0.65		111892	0.65	25078
0.001	4.05	2.63	0.62	33770	0.62	53477	185878	20938	33155	0.65		128762	0.65	25245
0.001	4.41	2.87	0.62	23878	0.62	56222	202462	14804	34858	0.65		144635	0.65	25332
0.001	4.77	3.10	0.62	15484	0.62	58553	219045	9600	36303	0.65		159736	0.65	25310
0.000	5.13	3.34	0.62	8271	0.62	60000	235628	5128	37200	0.65		174005	0.65	25158
0.000	5.49	3.57	0.62	2007	0.62	60000	252212	1244	37200	0.65		187309	0.65	24859
	5.85	3.81	0.62	-3484	0.62	60000	268795	-2160	37200	0.65		200301	0.65	24402
	6.22	4.04	0.62	-8338	0.62	60000	285379	-5169	37200	0.65		213036	0.65	23778
	6.58	4.27	0.62	-12658	0.62	60000	301962	-7848	37200	0.65	225556	223000	0.65	22979
	6.94	4.51	0.62	-16528	0.62	60000	318545	-10247	37200	0.65	237895	223000	0.65	21999
	7.30	4.74	0.62	-20015	0.62	60000	335129	-12409	37200	0.65	250080	223000	0.65	20835
	7.66	4.98	0.62	-23173	0.62	60000	351712	-14368	37200	0.65	262132	223000	0.65	19482
	8.02	5.21	0.62	-26047	0.62	60000	368296	-16149	37200	0.65	274069	223000	0.65	17938
	8.38	5.45	0.62	-28674	0.62	60000	384879	-17778	37200	0.65	285907	223000	0.65	16199
	8.74	5.68	0.62	-31083	0.62	60000	401462	-19271	37200	0.65	297657	223000	0.65	14265
	9.11	5.92	0.62	-33301	0.62	60000	418046	-20647	37200	0.65	309330	223000	0.65	12133
	9.47	6.15	0.62	-35350	0.62	60000	434629	-21917	37200	0.65	320935	223000	0.65	9801
	9.83	6.39	0.62	-37248	0.62	60000	451213	-23094	37200	0.65	332479	223000	0.65	7268
	10.19	6.62	0.62	-39012	0.62	60000	467796	-24187	37200	0.65	343969	223000	0.65	4534
	10.55	6.86	0.62	-40655	0.62	60000	484380	-25206	37200	0.65	355411	223000	0.65	1597
	∞									0.65	371667	223000		0

* The values in this column show what the Design Axial Strength would have been without the 0.60 multiplier

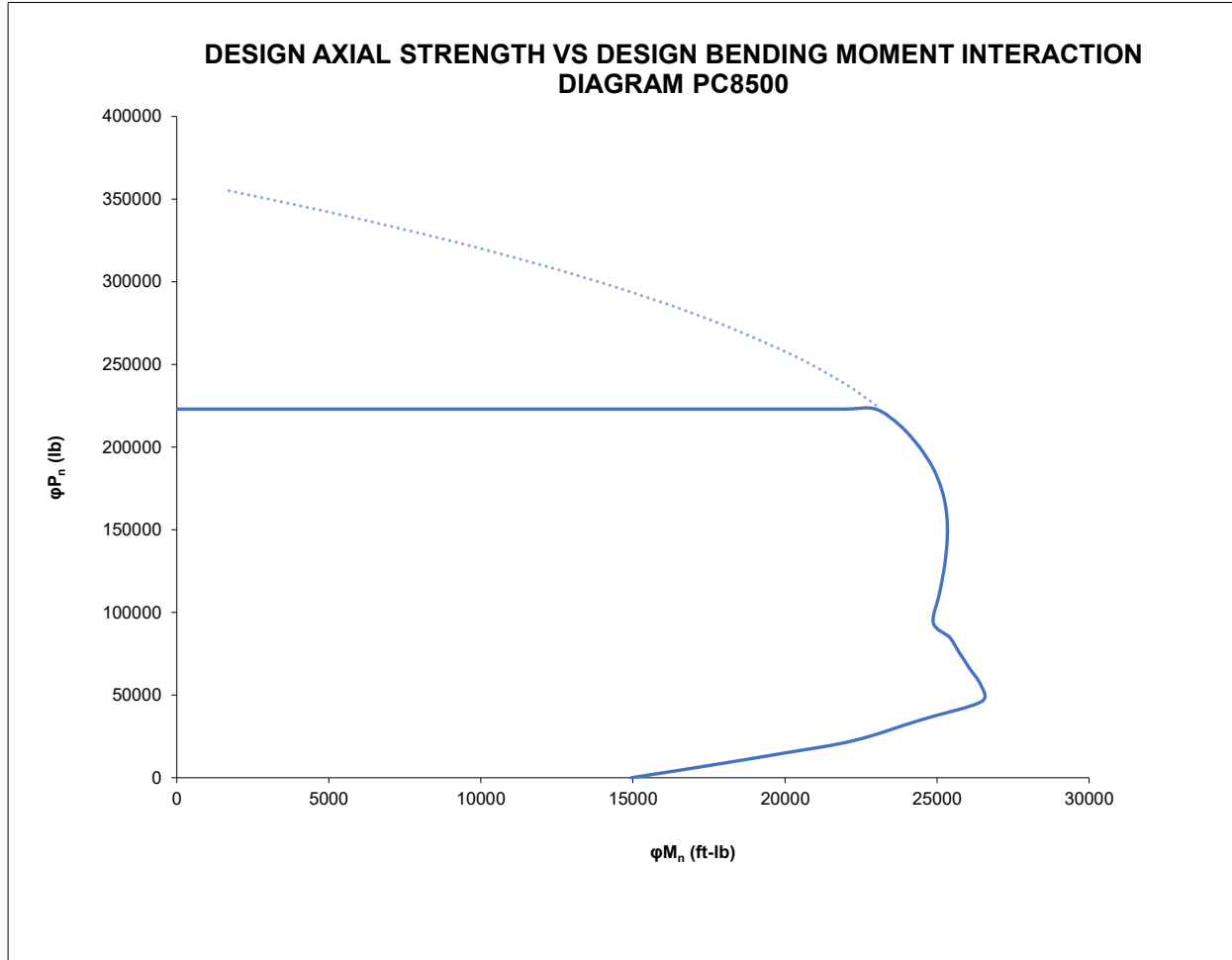

4. PERMA-COLUMN: SHEAR STRENGTH OF CONCRETE FOUNDATION

The design shear strength of the Perma-Column concrete foundation is calculated using ACI 318 equations 22.5.6.1 and 22.5.7.1. Because the depth of the concrete base is less than 10 inches, per ACI Table 9.6.3.1, the minimum shear reinforcement requirement of Section 10.6.2 and Section 9.6.3.1 does not apply.

The design shear strength is also expressed in terms of the allowable shear strength using a LRFD to ASD conversion factor of $\alpha = 1 / 1.6 = 0.625$. The calculations are completed in Microsoft Excel (2016) using the listed equations.

GOVERNING CODE:

Building Code Requirements for Structural Concrete, ACI 318-14

GOVERNING EQUATIONS:

Design Shear Strength (Compression): $\phi V_n = \phi 2(1+N_u/(2000A_g))(f'_c)^{0.5}bd$	(ACI 318, Eq. 22.5.6.1)
Design Shear Strength (Tension) $\phi V_n = \phi 2(1+N_u/(500A_g))(f'_c)^{0.5}bd$	(ACI 318, Eq. 22.5.7.1)

Strength Reduction Factor, ϕ	0.75		(ACI 318, Table 21.2.1)
LRFD to ASD Conversion Factor, α	0.625	$\alpha = 1 / 1.6$	
Concrete comp. strength, f'_c	10000 psi		

CALCULATIONS:

- ϕV_{n-x} = Design shear strength (LRFD) parallel to x-axis
- ϕV_{n-z} = Design shear strength (LRFD) parallel to z-axis
- V_{all-x} = Allowable shear strength (ASD) parallel to x-axis
- V_{all-z} = Allowable shear strength (ASD) parallel to z-axis
- N_u = Factored axial force normal to cross section occurring simultaneously with V_n ; to be taken as positive for compression and negative for tension

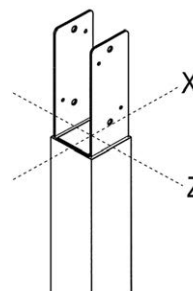

TABLE 4A: PERMA COLUMN DIMENSIONS FOR SHEAR STRENGTH CALCULATIONS					
Model ID	b_z (in)	d_x (in)	b_x (in)	d_z (in)	A_g (in ²)
PC4600	4.50	3.94	5.44	3.00	23.8
PC6300	5.38	3.94	5.44	3.88	29.3
PC6400	6.88	3.94	5.44	5.38	37.4
PC6600	6.38	3.94	5.44	4.88	34.7
PC8300	5.38	5.62	7.19	3.81	38.7
PC8400	6.88	5.62	7.19	5.31	49.5
PC8500	8.31	5.62	7.19	6.74	59.7

TABLE 4B: SHEAR STRENGTH OF PC4600 CONCRETE FOUNDATION

LRFD	LRFD	LRFD	ASD	ASD	ASD
N_u	ϕV_{n-x}	ϕV_{n-z}	N_u	V_{n-x}	V_{n-z}
(lb)	(lb)	(lb)	(lb)	(lb)	(lb)
10000	3218	2962	6250	2011	1851
9000	3162	2911	5625	1976	1819
8000	3106	2859	5000	1942	1787
7000	3051	2808	4375	1907	1755
6000	2995	2757	3750	1872	1723
5000	2939	2705	3125	1837	1691
4000	2883	2654	2500	1802	1659
3000	2827	2602	1875	1767	1626
2000	2771	2551	1250	1732	1594
1000	2715	2499	625	1697	1562
0	2660	2448	0	1662	1530
-1000	2436	2242	-625	1523	1401
-2000	2213	2037	-1250	1383	1273
-3000	1989	1831	-1875	1243	1144
-4000	1766	1625	-2500	1103	1016
-5000	1542	1419	-3125	964	887

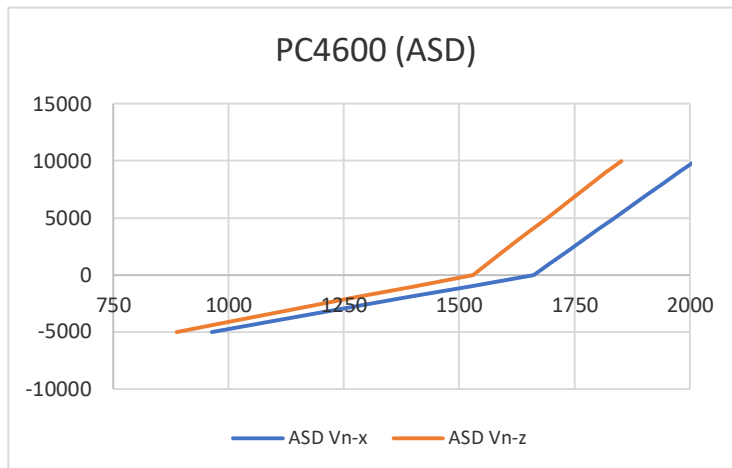
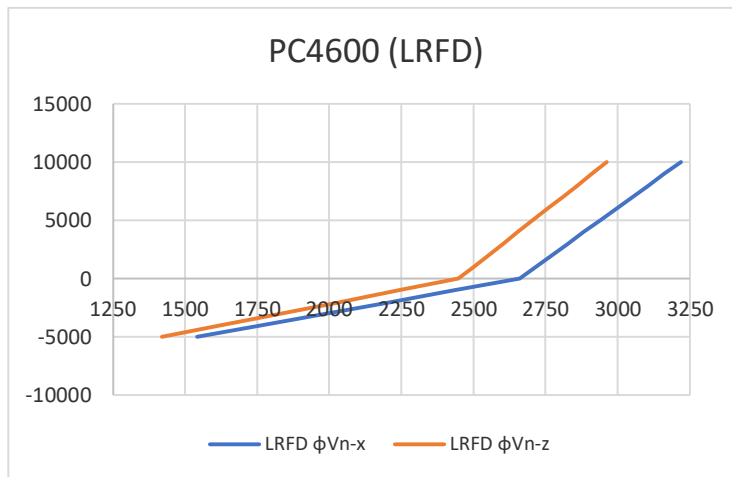

TABLE 4C: SHEAR STRENGTH OF PC6300 CONCRETE FOUNDATION

LRFD	LRFD	LRFD	ASD	ASD	ASD
N_u	ϕV_{n-x}	ϕV_{n-z}	N_u	V_{n-x}	V_{n-z}
(lb)	(lb)	(lb)	(lb)	(lb)	(lb)
10000	3722	3706	6250	2326	2316
9000	3668	3652	5625	2292	2283
8000	3614	3598	5000	2259	2249
7000	3559	3544	4375	2225	2215
6000	3505	3490	3750	2191	2181
5000	3451	3436	3125	2157	2148
4000	3397	3382	2500	2123	2114
3000	3342	3328	1875	2089	2080
2000	3288	3274	1250	2055	2046
1000	3234	3220	625	2021	2013
0	3180	3166	0	1987	1979
-1000	2963	2950	-625	1852	1844
-2000	2746	2734	-1250	1716	1709
-3000	2528	2518	-1875	1580	1574
-4000	2311	2302	-2500	1445	1439
-5000	2094	2086	-3125	1309	1303

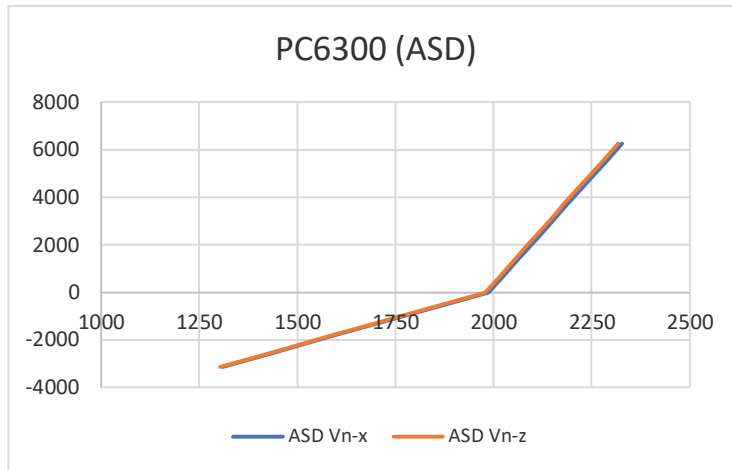
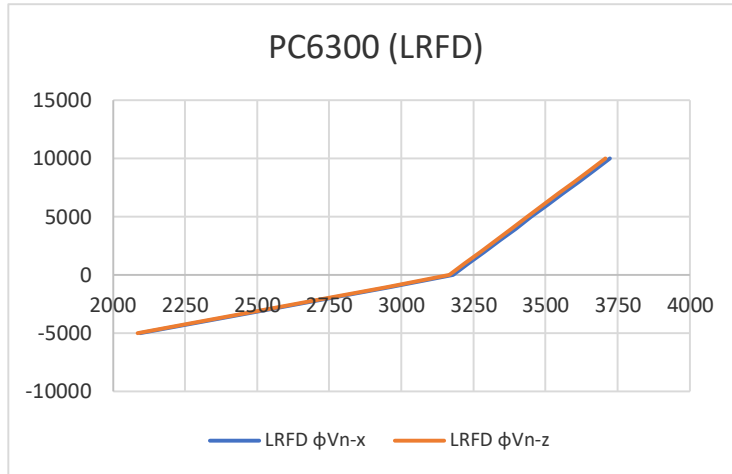

TABLE 4D: SHEAR STRENGTH OF PC6400 CONCRETE FOUNDATION

LRFD	LRFD	LRFD	ASD	ASD	ASD
N_u	ϕV_{n-x}	ϕV_{n-z}	N_u	V_{n-x}	V_{n-z}
(lb)	(lb)	(lb)	(lb)	(lb)	(lb)
10000	4610	4977	6250	2881	3111
9000	4555	4918	5625	2847	3074
8000	4501	4860	5000	2813	3037
7000	4447	4801	4375	2779	3001
6000	4392	4742	3750	2745	2964
5000	4338	4684	3125	2711	2927
4000	4284	4625	2500	2677	2891
3000	4229	4566	1875	2643	2854
2000	4175	4507	1250	2609	2817
1000	4120	4449	625	2575	2780
0	4066	4390	0	2541	2744
-1000	3849	4155	-625	2405	2597
-2000	3631	3921	-1250	2270	2450
-3000	3414	3686	-1875	2134	2304
-4000	3196	3451	-2500	1998	2157
-5000	2979	3216	-3125	1862	2010

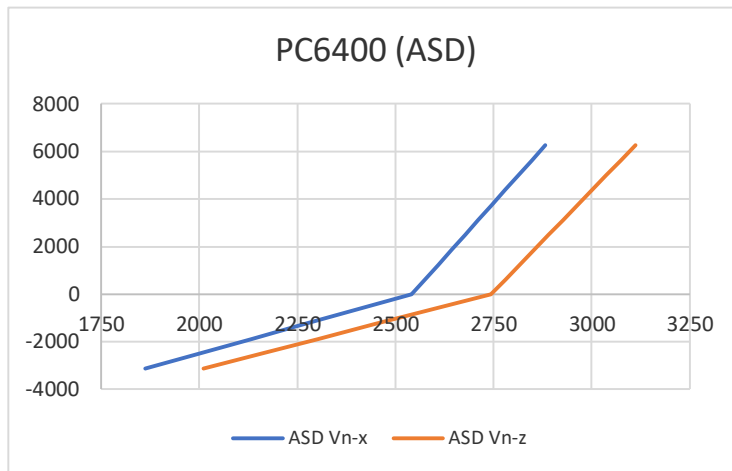
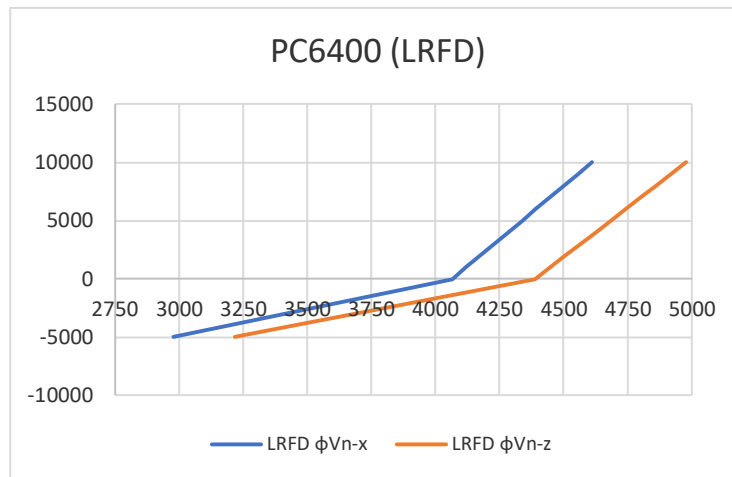

TABLE 4E: SHEAR STRENGTH OF PC6600 CONCRETE FOUNDATION

LRFD	LRFD	LRFD	ASD	ASD	ASD
N_u	ϕV_{n-x}	ϕV_{n-z}	N_u	V_{n-x}	V_{n-z}
(lb)	(lb)	(lb)	(lb)	(lb)	(lb)
10000	4314	4556	6250	2696	2847
9000	4260	4498	5625	2662	2812
8000	4205	4441	5000	2628	2776
7000	4151	4384	4375	2594	2740
6000	4097	4326	3750	2560	2704
5000	4042	4269	3125	2526	2668
4000	3988	4212	2500	2492	2632
3000	3934	4154	1875	2458	2596
2000	3879	4097	1250	2425	2561
1000	3825	4039	625	2391	2525
0	3771	3982	0	2357	2489
-1000	3553	3753	-625	2221	2345
-2000	3336	3523	-1250	2085	2202
-3000	3119	3294	-1875	1949	2058
-4000	2901	3064	-2500	1813	1915
-5000	2684	2835	-3125	1677	1772

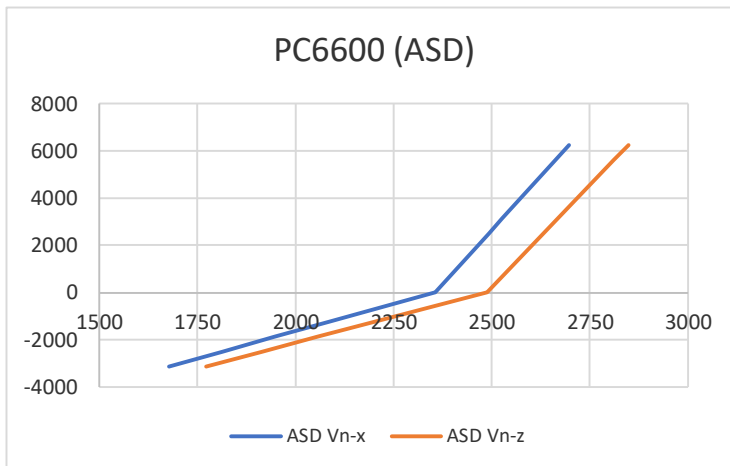
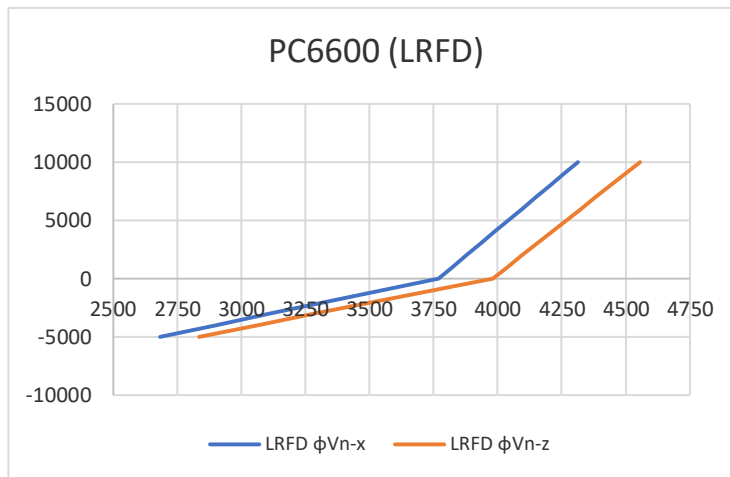

TABLE 4F: SHEAR STRENGTH OF PC8300 CONCRETE FOUNDATION

LRFD	LRFD	LRFD	ASD	ASD	ASD
N_u	ϕV_{n-x}	ϕV_{n-z}	N_u	V_{n-x}	V_{n-z}
(lb)	(lb)	(lb)	(lb)	(lb)	(lb)
10000	5121	4640	6250	3201	2900
9000	5063	4587	5625	3164	2867
8000	5004	4534	5000	3128	2834
7000	4946	4481	4375	3091	2800
6000	4887	4428	3750	3054	2767
5000	4828	4375	3125	3018	2734
4000	4770	4321	2500	2981	2701
3000	4711	4268	1875	2944	2668
2000	4653	4215	1250	2908	2635
1000	4594	4162	625	2871	2601
0	4535	4109	0	2835	2568
-1000	4301	3897	-625	2688	2435
-2000	4067	3684	-1250	2542	2303
-3000	3832	3472	-1875	2395	2170
-4000	3598	3260	-2500	2249	2037
-5000	3363	3047	-3125	2102	1905

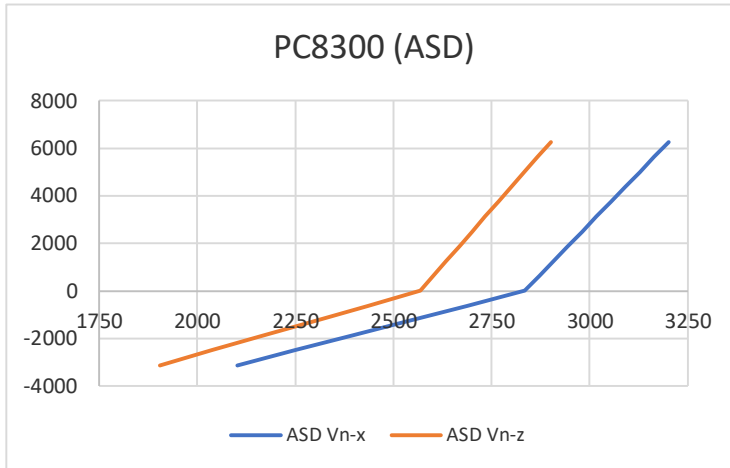
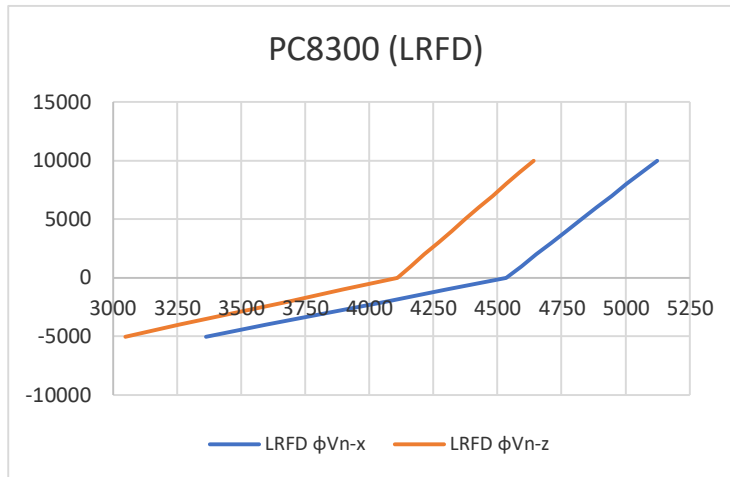

TABLE 4G: SHEAR STRENGTH OF PC8400 CONCRETE FOUNDATION

LRFD	LRFD	LRFD	ASD	ASD	ASD
N_u	ϕV_{n-x}	ϕV_{n-z}	N_u	V_{n-x}	V_{n-z}
(lb)	(lb)	(lb)	(lb)	(lb)	(lb)
10000	6386	6305	6250	3991	3941
9000	6327	6247	5625	3954	3905
8000	6269	6190	5000	3918	3869
7000	6210	6132	4375	3881	3832
6000	6151	6074	3750	3845	3796
5000	6093	6016	3125	3808	3760
4000	6034	5958	2500	3771	3724
3000	5976	5900	1875	3735	3688
2000	5917	5843	1250	3698	3652
1000	5858	5785	625	3662	3615
0	5800	5727	0	3625	3579
-1000	5566	5495	-625	3478	3435
-2000	5331	5264	-1250	3332	3290
-3000	5097	5033	-1875	3186	3145
-4000	4862	4801	-2500	3039	3001
-5000	4628	4570	-3125	2893	2856

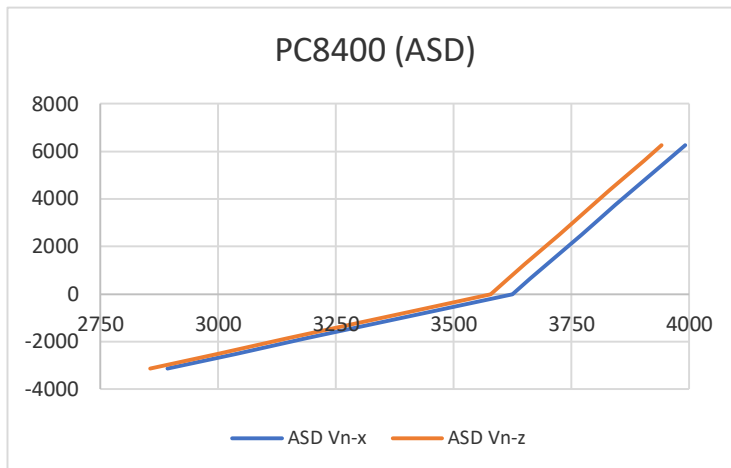
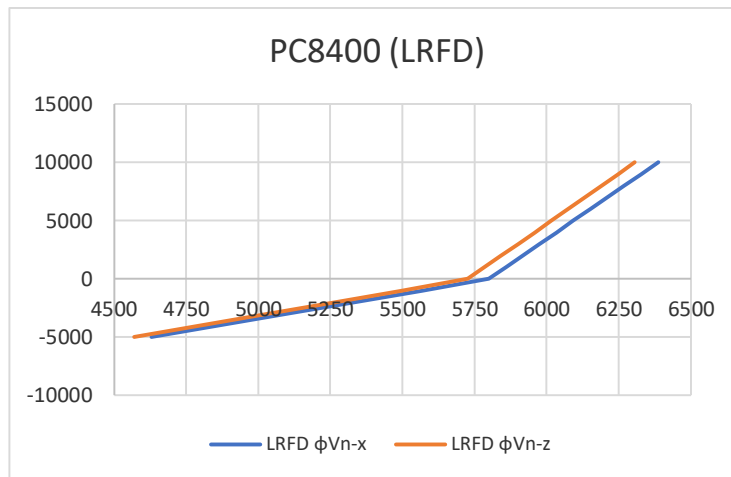
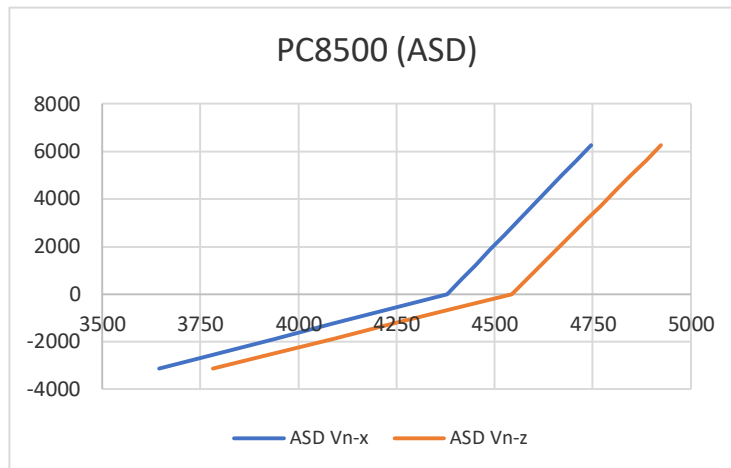
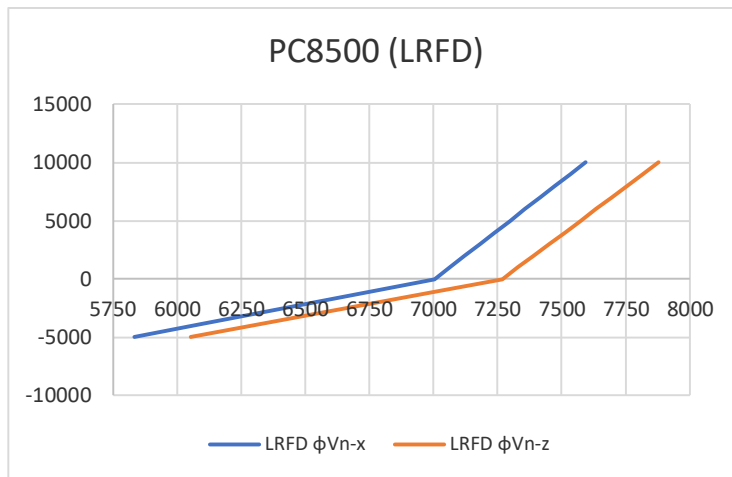

TABLE 4H: SHEAR STRENGTH OF PC8500 CONCRETE FOUNDATION

LRFD	LRFD	LRFD	ASD	ASD	ASD
N_u	ϕV_{n-x}	ϕV_{n-z}	N_u	V_{n-x}	V_{n-z}
(lb)	(lb)	(lb)	(lb)	(lb)	(lb)
10000	7592	7878	6250	4745	4924
9000	7533	7817	5625	4708	4886
8000	7475	7756	5000	4672	4848
7000	7416	7695	4375	4635	4810
6000	7357	7634	3750	4598	4771
5000	7299	7573	3125	4562	4733
4000	7240	7513	2500	4525	4695
3000	7181	7452	1875	4488	4657
2000	7123	7391	1250	4452	4619
1000	7064	7330	625	4415	4581
0	7005	7269	0	4378	4543
-1000	6771	7026	-625	4232	4391
-2000	6536	6782	-1250	4085	4239
-3000	6301	6539	-1875	3938	4087
-4000	6067	6295	-2500	3792	3934
-5000	5832	6051	-3125	3645	3782



5. PERMA-COLUMN: TENSION STRENGTH OF CONCRETE FOUNDATION AND BRACKET

The tension strength of the Perma-Column is dependent entirely on the strength of the external and internal steel components, steel-to-steel connections, and steel-to-wood connections: steel bracket, rebar, weld connection between rebar and steel bracket, weld connection between rebar and steel sleeve (pipe) at bottom, through bolt at bottom (through sleeve), external steel angles at bottom, and steel-to-wood connection above concrete. Under tension forces, the concrete around the steel components is considered non-structural. The calculations are presented in both the LRFD and ASD formats according to provisions of the governing code (AISC 360-16 and NDS 2015). The calculations are completed in Microsoft Excel (2016) using the listed equations. The internal loads in the steel saddle bracket are determined using Visual Analysis (v.18) by IES, Inc.

The load on each fastener type (screw, bolt) is proportional to the ratio of the slip-modulus of the fastener type to the cumulative slip-modulus all fasteners: $N_s k_s / k_g$, $N_b k_b / k_g$, where N_s is the quantity of screws per bracket, N_b is the quantity of bolts in double shear per bracket, k_s is the slip-modulus of one screw in single shear, k_b is the slip-modulus of one bolt in double shear, and k_g is the cumulative slip-modulus of all fasteners (Tables 5E and 5G). The slip-modulus of the screw fasteners does not equal the slip modulus of the bolt fastener(s): $N_s k_s \neq N_b k_b$. As a result, one fastener type is loaded to the maximum allowable or design lateral strength, while the second fastener type receives the balance of the load which will not reach the fastener's maximum capacity (Table 5G). The discussion and calculations for slip-modulus are provided in Section 6.

Table 5A shows the tensile strength of the PC based on tensile strength of rebar, weld strength, and vertical plates of the brackets. Table 5B shows the tensile strength of the PC based on the bending strength of the steel saddle. Table 5F shows the tensile strength of the PC based on the lateral (shear) strength of the steel-to-wood connection. Table 5H shows the tensile strength of the PC based on the shear and bearing strength of bolts through the uplift steel angles at the bottom of the foundation. Table 5I shows the tensile strength of the PC based on the bending strength of the uplift angles at the bottom of the foundation.

GOVERNING CODE:

Specification for Structural Steel Buildings ANSI/AISC 360-16
National Design Specification for Wood Construction, NDS (2015)

GOVERNING EQUATIONS:

● REBAR AND STEEL SADDLE: AISC 360, SECTION D2

Design Tensile Strength	$\phi P_n = \phi F_y A_g$ (tensile yielding)	$\phi = 0.90$	(D2-1)
	$\phi P_n = \phi F_u A_e$ (tensile rupture)	$\phi = 0.75$	(D2-2)
Allowable Tensile Strength	$P_n / \Omega = F_y A_g / \Omega$ (tensile yielding)	$\Omega = 1.67$	(D2-1)
	$P_n / \Omega = F_u A_e / \Omega$ (tensile rupture)	$\Omega = 2.00$	(D2-2)

● WELDS: AISC 360, SECTION J2

Design Strength	$\phi R_n = \phi F_w A_w$	$\phi = 0.75$	(J2-3)
Allowable Strength	$R_n / \Omega = F_w A_w / \Omega$	$\Omega = 2.00$	(J2-3)
	$F_w = 0.60 F_{EXX}$		(T. J2.5)

● BOLT: AISC 360, SECTION J3

Design Shear Strength	$\phi R_{nv} = \phi F_{nv} A_b$	$\phi = 0.75$	(J3-1)
Allowable Shear Strength	$R_{nv} / \Omega = F_{nv} A_b / \Omega$	$\Omega = 2.00$	(J3-1)
	$F_{nv} = 24 \text{ ksi}$	A307 Bolt	(T. J3.2)

• BEARING (BOLT & STEEL ANGLES AT BOTTOM): AISC 360, SECTION J3

Design Bearing Strength	$\phi R_n = \phi L_c t F_u \leq 3.0 dt F_u$	$\phi = 0.75$	(J3-6b)
Allowable Bearing Strength	$R_n / \Omega = L_c t F_u / \Omega \leq 3.0 dt F_u / \Omega$	$\Omega = 2.00$	(J3-6b)

• BENDING IN STEEL SADDLE BRACKET AND UPLIFT STEEL ANGLES: AISC 360, SECTIONS F1 & F11

Design Bending Strength	$\phi M_n = \phi F_y Z$	$\phi = 0.90$	(F1, F11)
Allowable Bending Strength	$M_n / \Omega = M_n Z / \Omega$	$\Omega = 1.67$	(F1, F11)

• STEEL-TO-WOOD CONNECTION (BOLT, SCREWS): NDS 2015

Allowable Lateral Strength of Screws	$Z'_{s, ASD} N_s = N_s Z C_D C_\Delta$	NDS Table 11.3.1
Design Lateral Strength of Screws	$Z'_{s, LRFD} N_s = \phi N_s Z \lambda C_\Delta K_F$	NDS Table 11.3.1
Allowable Lateral Strength of Bolt(s)	$Z'_{b, ASD} N_b = N_b Z C_D C_\Delta$	NDS Table 11.3.1
Design Lateral Strength of Bolt(s)	$Z'_{b, LRFD} N_b = \phi N_b Z \lambda C_\Delta K_F$	NDS Table 11.3.1

Z = Unadjusted reference lateral (shear) design value for one fastener NDS Table 12.3.1A
 Z' = Adjusted lateral design value for one fastener NDS Table 11.3.1
 C_D = ASD load duration factor NDS Table 2.3.2
 C_Δ = Geometry factor NDS 12.5.1
 N = total quantity of fasteners in the group
 φ = LRFD resistance factor NDS Table N2
 λ = LRFD time effect factor NDS Table N3
 K_F = ASD to LRFD format conversion factor NDS Table N1
 Subscript "s" = screws
 Subscript "b" = bolts

Allowable Lateral Strength of Mixed Fasteners	$V_a = \min [Z'_{s, ASD} (k_g/k_s), Z'_{b, ASD} (k_g/k_b)]$
Design Lateral Strength of Mixed Fasteners	$\phi V = \min [Z'_{s, LRFD} (k_g/k_s), Z'_{b, LRFD} (k_g/k_b)]$

CALCULATIONS:

STEEL SADDLE BRACKET PROPERTIES

Minimum Tensile Strength, F _u	60	ksi
Minimum Yield Strength, F _y	40	ksi
Thickness of steel, t	0.250	in

BOLT PROPERTIES

Bolt Diameter, D _b	0.5	in
Bolt Area, A _b	0.20	in ²
Bolt Designation	A307	
Nominal Shear Strength, F _{nv}	24	ksi
Minimum Tensile Strength, F _u	60	ksi

WELD PROPERTIES

Effective Weld Thickness (throat), t _e	0.25	in (min)
Electrode Classification Number	70	ksi
Nominal Strength of Weld Metal, F _w	42	ksi

STEEL ANGLE PROPERTIES

Minimum Tensile Strength, F _u	58	ksi
Minimum Yield Strength, F _y	36	ksi
Clear distance from hole to edge, L _c	1.0	in
Thickness of steel angle(s), t	0.125	in

REBAR PROPERTIES

Rebar Yield Strength, F _y	60	ksi
--------------------------------------	----	-----

TABLE 5A: DESIGN TENSILE STRENGTH AND ALLOWABLE TENSILE STRENGTH (REBAR, WELDS, AND VERTICAL STEEL PLATES)

Model ID	Tensile Strength of Rebar and Welds						Tensile Strength of Steel Saddle Vertical Plates					
	Rebar Tensile Strength			Weld Strength			Yielding			Rupture		
	A_s (in ²)	LRFD ϕR_n (lbf)	Asd R_n / Ω (lbf)	A_w (in ²)	LRFD ϕR_n (lbf)	ASD R_n / Ω (lbf)	A_g (in ²)	LRFD ϕR_n (lbf)	ASD R_n / Ω (lbf)	A_e (in ²)	LRFD ϕR_n (lbf)	ASD R_n / Ω (lbf)
PC4600	0.80	43200	28743	1.57	49455	32970	2.5	90000	59880	2.19	98550	65700
PC6300	0.80	43200	28743	1.57	49455	32970	2.5	90000	59880	2.19	98550	65700
PC6400	0.80	43200	28743	1.57	49455	32970	2.5	90000	59880	2.19	98550	65700
PC6600	0.80	43200	28743	1.57	49455	32970	2.5	90000	59880	2.19	98550	65700
PC8300	1.24	66960	44551	1.96	61740	41160	3.5	126000	83832	3.19	143550	95700
PC8400	1.24	66960	44551	1.96	61740	41160	3.5	126000	83832	3.19	143550	95700
PC8500	1.24	66960	44551	1.96	61740	41160	3.5	126000	83832	3.19	143550	95700

TABLE 5B: DESIGN TENSILE STRENGTH AND ALLOWABLE TENSILE STRENGTH AS DEFINED BY THE BENDING STRENGTH OF THE STEEL SADDLE

Model ID	t (in)	w (in)	F_y (ksi)	Z (in ³)	ϕM_n (in-lb)	M_n / Ω (in-lb)	k (in ²)	LRFD ϕT_n (lb)	ASD T_n / Ω (lb)
PC4600	0.250	5.00	40	0.078	2813	1871	0.3326	8460	5630
PC6300	0.250	5.00	40	0.078	2813	1871	0.2725	10320	6870
PC6400	0.250	5.00	40	0.078	2813	1871	0.3102	9070	6030
PC6600	0.250	5.00	40	0.078	2813	1871	0.3005	9360	6230
PC8300	0.250	7.00	40	0.109	3938	2620	0.2507	15710	10450
PC8400	0.250	7.00	40	0.109	3938	2620	0.2898	13590	9040
PC8500	0.250	7.00	40	0.109	3938	2620	0.3191	12340	8210

(1) t = thickness of steel plate (saddle)

(2) w = width of steel plate (saddle)

(3) Z is plastic section modulus = $w t^2 / 4$

(3) Factor "k" represents the maximum moment found anywhere in the steel saddle under 1 pound of tension force. This factor was determined using a two dimensional computer model for each PC model and equals Moment divided by total applied downward force, $k = M/F$.

(4) Tension strength, as defined by the bending strength of the steel saddle bracket, is determined using the following expressions:
 $\phi T_n = \phi M_n / k$, $T_n / \Omega = (M_n / k) / \Omega$

TABLE 5C: ADJUSTED LATERAL DESIGN VALUE OF ONE SCREW: NDS Table 12.3.1A

		SDS	F_{yb}	164000	$1+R_e$	1.1	θ	0		
Screw Diameter (in)	D	0.242	$F_{em,par}$	5526	$2+R_e$	2.1	I_m	1259.3		
Screw Length (in)	L	3	$F_{em,perp}$	5526	k_1	0.408	I_s	1280.4		
Thickness of Steel Plate Member (in)	t_s	0.25	F_{em}	5526	k_2	0.536	II	522.4		
Thickness of Wood Member (in)	t_m	4.5	R_e	0.089	k_3	6.944	III_m	572.7		
Screw Penetration into main member (in)	p	2.75	R_t	11.000	$F_{es,par}$	61800	III_s	380.5		
Minimum Allowed Penetration, $p_{min} = 6D$	p_{min}	1.5	K_o	2.920	$F_{es,perp}$	61800	IV	472.3		
Specific Gravity of Wood Member	G	0.55	ρ	2.8	F_{es}	61800	D_r	0.242		
Lateral Design Value (lbs)	Z	380			LRFD resistance factor		ϕ	0.65		
ASD Load Duration Factor	C_D	1.6			LRFD time effect factor		λ	1		
Geometry Factor	C_{Δ}	1			ASD to LRFD format conversion factor		K_F	3.32		
ASD Adjusted Lateral Design Value (lbs)	$Z'_{s,ASD}$	609			LRFD Adjusted Lateral Design Value (lbs)	$Z'_{s,LRFD}$	821			

TABLE 5D: ADJUSTED LATERAL DESIGN VALUE OF ONE BOLT (DOUBLE SHEAR): NDS Table 12.3.1A

Bolt Diameter (in)	D	0.5	$F_{em,par}$	6160	K_{θ}	1.000	I_m	3465		
Main Member Thickness (in)	$t_{m,min}$	4.5	$F_{em,perp}$	3626	$1+R_e$	1.071	III_s	1720		
Side Member Thickness (in)	t_s	0.25	F_{em}	6160	$2+R_e$	2.071	IV	2053		
Dowel Bearing Strength (psi)	F_{es}	87000	R_e	0.071	k_3	7.402				
Bolt Yield Strength (psi)	F_{yb}	45000								
Max Angle Load to Grain (deg)	θ	0								
Specific Gravity	G	0.55								
Reference Lateral Design Value (Z)	Z	1720			LRFD resistance factor		ϕ	0.65		
ASD Load Duration Factor	C_D	1.6			LRFD time effect factor		λ	1		
Geometry Factor	C_{Δ}	1			ASD to LRFD format conversion factor		K_F	3.32		
ASD Adjusted Lateral Design Value (lbs)	$Z'_{b,ASD}$	2752			LRFD Adjusted Lateral Design Value (lbs)	$Z'_{b,LRFD}$	3712			

TABLE 5E: FASTENER SLIP-MODULUS					
Model	k_s (lb/in)	k_b (lb/in)	N_s	N_b	k_g (lb/in)
PC4600	32143	95459	4	2	319491
PC6300	32143	95459	4	2	319491
PC6400	32143	95459	4	2	319491
PC6600	32143	95459	4	2	319491
PC8300	32143	95459	8	2	448063
PC8400	32143	95459	8	2	448063
PC8500	32143	95459	8	2	448063

Fastener slip-modulus values calculated per FP, 2010, USDA-FS

Model	$Z'_{s, LRFD}$ (k_g/k_s)	$Z'_{b, LRFD}$ (k_g/k_b)	$Z'_{s, ASD}$ (k_g/k_s)	$Z'_{b, ASD}$ (k_g/k_b)	LRFD	ASD
	(lb)	(lb)	(lb)	(lb)	ϕV (lb)	V_a (lb)
PC4600	8161	12424	6051	9211	8161	6051
PC6300	8161	12424	6051	9211	8161	6051
PC6400	8161	12424	6051	9211	8161	6051
PC6600	8161	12424	6051	9211	8161	6051
PC8300	11446	17423	8486	12918	11446	8486
PC8400	11446	17423	8486	12918	11446	8486
PC8500	11446	17423	8486	12918	11446	8486

Model	Load Distribution		Load / Strength	
	Screws	Bolts	Screws	Bolts
	PC4600	40.2%	59.8%	100%
PC6300	40.2%	59.8%	100%	66%
PC6400	40.2%	59.8%	100%	66%
PC6600	40.2%	59.8%	100%	66%
PC8300	57.4%	42.6%	100%	66%
PC8400	57.4%	42.6%	100%	66%
PC8500	57.4%	42.6%	100%	66%

Model	LRFD	ASD
	ϕT_n (lb)	T_n / Ω (lb)
PC4600	6,515	4,835
PC6300	6,515	4,835
PC6400	6,515	4,835
PC6600	6,515	4,835
PC8300	11,450	8,490
PC8400	11,450	8,490
PC8500	11,450	8,210

NOTE: uplift values for PC 4600, 6300, 6400 and 6600 models have been reduced per latest test (values are limited by 1/8" displacement criterion)

Model ID	Bolt Shear Strength (Double Shear)				Bolt Bearing Strength (2) Steel Angles at Bottom of Foundation					
	A_b	F_{nv}	LRFD	ASD	L_c	d	t	F_u	LRFD	ASD
	(in ²)	(ksi)	ϕR_{nv} (lbf)	R_{nv} / Ω (lbf)	(in)	(in)	(in)	(ksi)	ϕR_n (lbf)	R_n / Ω (lbf)
PC4600	0.2	24	8640	4800	1	0.5	0.125	58	16313	10875
PC6300	0.2	24	8640	4800	1	0.5	0.125	58	16313	10875
PC6400	0.2	24	8640	4800	1	0.5	0.125	58	16313	10875
PC6600	0.2	24	8640	4800	1	0.5	0.125	58	16313	10875
PC8300	0.2	24	8640	4800	1	0.5	0.125	58	16313	10875
PC8400	0.2	24	8640	4800	1	0.5	0.125	58	16313	10875
PC8500	0.2	24	8640	4800	1	0.5	0.125	58	16313	10875

TABLE 5J: TENSILE STRENGTH AS DEFINED BY THE BENDING STRENGTH OF UPLIFT STEEL ANGLES									
Model ID	L (in)	L _{EQ} (in)	Z (in ³)	N _a	φM _n (in-lb)	M _n / Ω (in-lb)	x (in)	LRFD φT _n (in-lb)	ASD T _n / Ω (in-lb)
PC4600	8.000	3.10	0.012	2	392	261	0.37	2121	1411
PC6300	8.000	3.10	0.012	2	392	261	0.37	2121	1411
PC6400	8.000	3.10	0.012	2	392	261	0.37	2121	1411
PC6600	8.000	3.10	0.012	2	392	261	0.37	2121	1411
PC8300	8.000	3.10	0.012	2	392	261	0.37	2121	1411
PC8400	8.000	3.10	0.012	2	392	261	0.37	2121	1411
PC8500	8.000	3.10	0.012	2	392	261 <td 0.37	2121	1411	

(1) L is actual length of steel angle

(2) L_{EQ} is the equivalent length or the effective length of the steel angle where the downward forces of the resisting soils are equated to a uniformly distributed load. From the perspective of the flexural stiffness, in views parallel and perpendicular to the angle's long axis, the soil resistance forces are expected to have a linear distribution, starting with zero value at least rigid locations (free ends) and increasing to the maximum value at most rigid locations (center, vertex). The torsional stiffness of the angles, however, also affects the soil load distribution along the angle's length - torsional stiffness is highest near the bolt and lowest near the free ends - resulting in a non-linear load distribution as shown in the figure on the right. The L_{EQ} is therefore approximated to be little under L/2. The results of this method are consistent with the finite element analysis performed in earlier calculations.

(3) Z is the plastic section modulus along the L_{EQ} length of one angle = L_{EQ}t² / 4

(4) N_a is the quantity of angles per deck post

(5) x is the distance between downward force W and the location where the thickness of the steel angle starts to increase (near vertex), see the figure on the right. This is the point where the ratio between the bending forces and the bending strength is the greatest. From this point, the bending forces continue to increase linearly, while the bending strength of the steel angle (leg), increases exponentially.

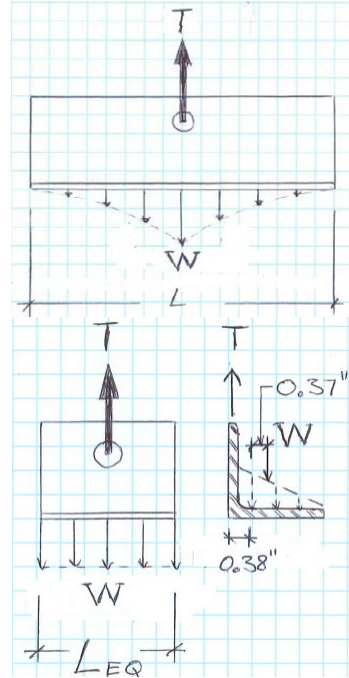

(6) The design tensile strength and the allowable tensile strength, as defined by the bending strength of the steel angles, is determined as follows: $\phi T_n = \phi M_n / x$, $T_n / \Omega = (M_n / \Omega) / x$

6. PERMA COLUMN: ROTATIONAL STIFFNESS OF STEEL BRACKET

The effective rotational stiffness of the Perma-Column steel bracket consists of three parts, three rotational springs arranged in series:

- (1) $(M/\theta)_f$, the rotational stiffness of the steel-to-wood connection (slip-modulus of the dowel fasteners)
- (2) $(M/\theta)_s$, the rotational stiffness of the steel saddle (3d finite element analysis in a structural design computer program)
- (3) $(M/\theta)_r$, the rotational stiffness resulting from the axial deformation in the tension rebar

Each PC steel bracket is fastened to wood column with 0.242"x3" structural screws and 1/2" SAE J429 Grade 5 through bolts. There are two fastener groups, the top fastener group and the bottom fastener group. The centroids of the fastener groups are separated by the distance "s" (Table 6A). To calculate the rotational stiffness of the steel-to-wood connection, it is necessary to first determine the slip-modulus for the 0.242" structural screw and the 1/2" through bolt. Per the Wood Handbook (FPL, 2010, United States Department of Agriculture Forest Service) the fastener slip-modulus for dowels loaded in single shear in steel-to-wood application can be calculated using the following expression: $k = 270,000 D^{1.5}$, where k is the slip-modulus and D is the fastener diameter. The slip modulus equation, however, does not include slippage due to fastener-hole clearance: a fastener has the freedom to move laterally with respect to the steel plate until it comes in contact with the edge of the hole in the steel plate. The holes for the screws and the bolts are 5/16" and 5/8" respectively. If the fasteners are installed precisely through the center of the holes in the steel plate, the clearance on either side the screw and the bolt is approximately 1/32" and 1/16", respectively. The screws will be engaged and start transferring load before the bolt may come in contact with the edge of the hole in the steel plate. For this reason, the slip-modulus of the bolt is reduced proportionally to the ratio of clearances: $(1/32") / (1/16") = 0.5$, or 50%. The slip-modulus for each fastener group and the resulting rotational stiffness for each model is shown in Table 6B.

The rotational stiffness of the steel bracket below the top of the concrete is attributed mostly to the axial deformation of the tension rebar. Since the axial forces in the rebar are linearly decreasing from maximum to zero along the rebar development length, L_d , the effective length used in calculating axial rebar stiffness is equal to the lesser of $L_d / 2$. The rotational stiffness of the steel saddle, $(M/\theta)_s$, and the rebar $(M/\theta)_r$, is analyzed jointly using a finite element analysis in Visual Analysis by IES, and the effective rotational stiffness is designated as $(M/\theta)_{s,r}$. Figure 6 shows a sketch of the finite element analysis model with supports. All springs have infinite stiffness and are set to only provide resistance to compression forces. A 1000 in-lb moment is applied to all models via the F_T and F_B forces, which are equal in magnitude and opposite in direction, $F_T = F_B = M/s$. The horizontal displacement Δ at force F_T (top fastener group) is divided by y to obtain the angle of rotation, θ , in radians, $\theta = \Delta / y$. The rotational stiffness $(M/\theta)_{s,r} = M / \theta$. The results of the analysis for each model are summarized in Table 6C.

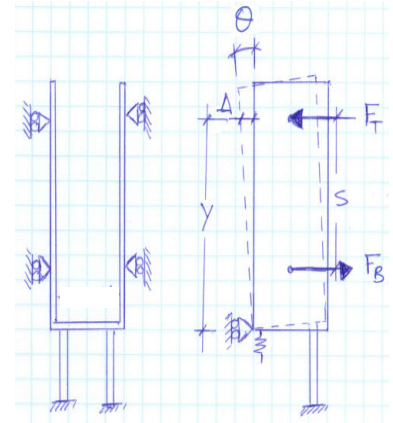

Figure 6

The effective rotational stiffness for each model, consisting of the steel-to-wood element and, the steel saddle and the rebar, is shown in Table 6D. The calculations are completed in Visual Analysis by IES and Microsoft Excel (2016) using the listed equations.

GOVERNING EQUATIONS:

Effective Rotational Stiffness	$(M/\theta)_e = [1 / (M/\theta)_f + 1 / (M/\theta)_{s,r}]^{-1}$	
Rotational Stiffness of Steel-to-Wood	$(M/\theta)_f = k s^2 / 2$	
Rotational Stiffness of Saddle and Rebar	$(M/\theta)_{s,r}$ = determined from finite element analysis	
Slip Modulus for (1) screw, single shear	$k_s = 270,000 D_s^{1.5}$	FPL, Chapter 8
Slip Modulus for (1) bolt, double shear	$k_b = 0.5 [2(270,000) D_b^{1.5}]$	(see discussion above)
Slip Modulus for a Fastener Group	$k_g = N_s k_s + N_b k_b$	
Rebar Development Length	$L_d = [(3/40)(f_y / \sqrt{f'_c}) (\Psi_t \Psi_e \Psi_s) / c_b] d_b^2$	(ACI 318-14, Eq. 25.4.2.3a)

s = distance between the centroids of the top and bottom fastener groups

N_s = quantity of screws in one fastener group

N_b = quantity of bolts in one fastener group

D_s = screw diameter

D_b = bolt diameter

CALCULATIONS:

Model	k_s (lb/in)	k_b (lb/in)	Elevation (in)									s (in)
			Base	Bolt 1	Screw 1	Screw 2	Screw 3	Screw 4	Bolt 2	Bottom	Top	
PC4600	32143	95459	0	3.375	4.375	n/a	n/a	11.125	12.125	3.627	11.87	8.25
PC6300	32143	95459	0	3.375	4.375	n/a	n/a	11.125	12.125	3.627	11.87	8.25
PC6400	32143	95459	0	3.375	4.375	n/a	n/a	16.125	17.125	3.627	16.87	13.25
PC6600	32143	95459	0	3.375	4.375	n/a	n/a	11.125	12.125	3.627	11.87	8.25
PC8300	32143	95459	0	3.875	4.875	6.875	14.125	16.125	17.125	4.680	16.32	11.64
PC8400	32143	95459	0	3.875	4.875	6.875	14.125	16.125	17.125	4.680	16.32	11.64
PC8500	32143	95459	0	3.875	4.875	6.875	14.125	16.125	17.125	4.680	16.32	11.64

Model	D_s (in)	D_b (in)	k_s (lb/in)	k_b (lb/in)	N_s	N_b	k_g (lb/in)	s (in)	$(M/\theta)_f$ (in-kip/rad)	$(M/\theta)_f$ (in-kip/deg)
PC4600	0.242	0.50	32143	95459	2	1	159745	8.25	5,000	94.8
PC6300	0.242	0.50	32143	95459	2	1	159745	8.25	5,000	94.8
PC6400	0.242	0.50	32143	95459	2	1	159745	13.25	14,000	245
PC6600	0.242	0.50	32143	95459	2	1	159745	8.25	5,000	94.8
PC8300	0.242	0.50	32143	95459	4	1	224032	11.64	15,000	265
PC8400	0.242	0.50	32143	95459	4	1	224032	11.64	15,000	265
PC8500	0.242	0.50	32143	95459	4	1	224032	11.64	15,000	265

Model	$L_d / 2$ (in)	M (in-lb)	θ (rad)	$(M/\theta)_{s,r}$ (in-kip/rad)	$(M/\theta)_{s,r}$ (in-kip/deg)
PC4600	9.0	1000	0.000295	3350	59.2
PC6300	5.7	1000	0.000295	3350	59.2
PC6400	5.4	1000	0.000314	3150	55.6
PC6600	5.4	1000	0.000301	3300	58.0
PC8300	9.3	1000	0.000144	6900	121
PC8400	8.4	1000	0.000149	6700	117
PC8500	8.4	1000	0.000154	6450	113

Model	$(M/\theta)_e$ (in-kip/rad)	$(M/\theta)_e$ (in-kip/deg)
PC4600	2000	36.4
PC6300	2000	36.4
PC6400	2550	45.3
PC6600	1950	36.0
PC8300	4700	83.2
PC8400	4600	81.2
PC8500	4500	79.4

7. PERMA COLUMN: BENDING AND SHEAR STRENGTH OF STEEL-TO-WOOD CONNECTION

The shear and bending forces are transferred from the wood column into the steel bracket via 0.242"x3" structural screws and 1/2" through bolts. The calculations below are for wood columns with specific gravity, SG, of 0.55 and higher. The calculations assume a rotationally stiff concrete foundation (soil, concrete collar) to ensure that moment reversal (location of zero moment) occurs above the bracket, not below (Figure 7A). The distance between the centroids of the top and bottom fastener groups, s , and the distance from the bottom of column to the centroid of the bottom fastener group, a , are specified in tables below. The PC brackets are designed to transfer shear, V and bending moment, M , forces as measured at the bottom of the steel bracket. There are four load cases to consider, see Figure 7B. Load Case 1 defines maximum shear strength, V_{max} , of the column-to-bracket connection in absence of moment forces. Load Case 2 defines the maximum moment strength, M_{max} , of the column-to-bracket connection in absence of shear forces. Load Case 3 is a combination of Load Case 1 and Load Case 2 where a maximum moment and a maximum shear force are applied to the bracket simultaneously. In all load cases, maximum shear strength V_{max} , and maximum moment strength, M_{max} , are defined such that the magnitude of the resulting forces F_T (force at the top fastener group) and F_B (force at the bottom fastener group) does not exceed the lateral strength of each respective fastener group.

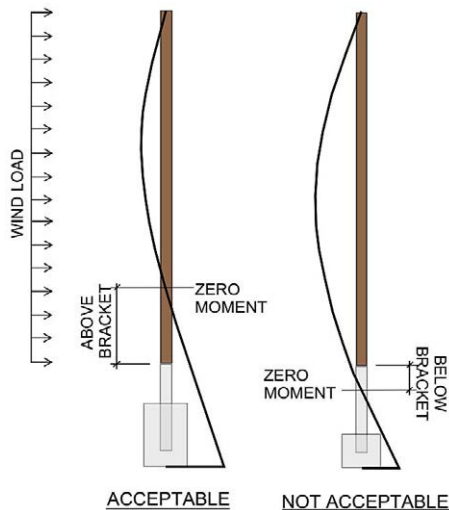

FIGURE 7A

The resulting forces F_T and F_B in Load Case 1 are acting in opposite direction from the resulting forces F_T and F_B in Load Case 2. This means that adding a shear load to the connection that is loaded with the maximum moment force will result in reduction in forces F_T and F_B . Similarly, adding a moment force to the connection that is loaded with the maximum shear force will result in reduction in forces F_T and F_B . Therefore, V_{max} and M_{max} loading may be applied to the bracket simultaneously without any reduction in strength. Load Case 4 represents the condition in which the moment reversal occurs below the bracket. In this load condition, M_{max} , as determined by Load Condition 2, cannot be used in combination with a shear force of any magnitude and V_{max} , as determined by Load Condition 1, cannot be used in combination with moment force of any magnitude. As shear force increases moment strength decreases, and as moment force increases shear strength decreases. This condition is rare and should not occur when foundation is properly designed.

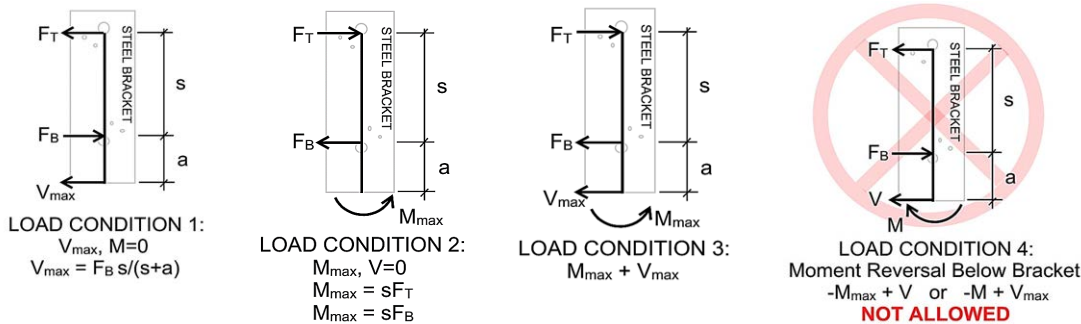

FIGURE 7B

The load on each fastener type (screw, bolt) within the fastener group is proportional to the ratio of the slip-modulus of the fastener type to the cumulative slip-modulus of the entire fastener group: $N_s k_s / k_g, N_b k_b / k_g$, where N_s is the quantity of screws within the fastener group, N_b is the quantity of bolts in double shear within the fastener group, k_s is the slip-modulus of one screw in single shear, k_b is the slip-modulus of one bolt in double shear, and k_g is the cumulative slip-modulus of the entire fastener group (Table 6B). The slip-modulus of the screw fasteners does not equal the slip modulus of the bolt fastener(s): $N_s k_s \neq N_b k_b$. As a result, one fastener type is loaded to the maximum allowable or design lateral strength, while the second fastener type receives the balance of the load which will not reach the fastener's maximum capacity (Tables 7C and 7D).

The allowable bending and shear strength (ASD) and the design bending strength and shear strength (LRFD) of the steel-to-wood connection for each model is shown in Table 7E. The calculations are completed in Microsoft Excel (2016) using the listed equations.

GOVERNING CODE:

National Design Specification for Wood Construction, NDS (2015)

GOVERNING EQUATIONS:

Allowable Lateral Strength of Screws	$Z'_{s, ASD} N_s = N_s Z C_D C_{\Delta}$	NDS Table 11.3.1
Design Lateral Strength of Screws	$Z'_{s, LRFD} N_s = \phi N_s Z \lambda C_{\Delta} K_F$	NDS Table 11.3.1
Allowable Lateral Strength of Bolt(s)	$Z'_{b, ASD} N_b = N_b Z C_D C_{\Delta}$	NDS Table 11.3.1
Design Lateral Strength of Bolt(s)	$Z'_{b, LRFD} N_b = \phi N_b Z \lambda C_{\Delta} K_F$	NDS Table 11.3.1

- Z = Unadjusted reference lateral (shear) design value for one fastener NDS Table 12.3.1A
- Z' = Adjusted lateral design value for one fastener NDS Table 11.3.1
- C_D = ASD load duration factor NDS Table 2.3.2
- C_Δ = Geometry factor NDS 12.5.1
- N = total quantity of fasteners in the group
- φ = LRFD resistance factor NDS Table N2
- λ = LRFD time effect factor NDS Table N3
- K_F = ASD to LRFD format conversion factor NDS Table N1
- Subscript "s" = screws
- Subscript "b" = bolts

Allowable Lateral Strength of Fastener Group	$V_a = \min [Z'_{s, ASD} (k_g/k_s), Z'_{b, ASD} (k_g/k_b)]$
Design Lateral Strength of Fastener Group	$\phi V = \min [Z'_{s, LRFD} (k_g/k_s), Z'_{b, LRFD} (k_g/k_b)]$

Allowable Bending Strength of Connection	$M_a = s NZ'_{ASD}$
Design Bending Strength of Connection	$\phi M_n = s NZ'_{LRFD}$

s = distance between the centroids of the fastener groups

CALCULATIONS:**TABLE 7A: ADJUSTED LATERAL DESIGN VALUE OF ONE SCREW: NDS Table 12.3.1A (Yield Limit Equations)**

			F_{yb}	164000	$1+R_e$	1.1	θ	90
Screw Diameter (in)	D	0.242	$F_{em, par}$	5526	$2+R_e$	2.1	I_m	1259.3
Screw Length (in)	L	3	$F_{em, perp}$	5526	k_1	0.408	I_s	1280.4
Thickness of Steel Plate Member (in)	l_s	0.25	F_{em}	5526	k_2	0.536	II	522.4
Thickness of Wood Member (in)	l_m	4.5	R_e	0.089	k_3	6.944	III _m	572.7
Screw Penetration into main member (in)	p	2.75	R_t	11.000	$F_{es, par}$	61800	III _s	380.5
Minimum Allowed Penetration, $p_{min} = 6D$	p_{min}	1.5	K_o	2.920	$F_{es, perp}$	61800	IV	472.3
Specific Gravity of Wood Member	G	0.55	ρ	2.8	F_{es}	61800	D_r	0.242
Lateral Design Value (lbs)	Z	380		LRFD resistance factor		ϕ		0.65
ASD Load Duration Factor	C_D	1.6		LRFD time effect factor		λ		1
Geometry Factor	C_{Δ}	1		ASD to LRFD format conversion factor		K_F		3.32
ASD Adjusted Lateral Design Value (lbs)	$Z'_{s, ASD}$	609		LRFD Adjusted Lateral Design Value (lbs)		$Z'_{s, LRFD}$		821

TABLE 7B: ADJUSTED LATERAL DESIGN VALUE OF ONE BOLT (DOUBLE SHEAR): NDS Table 12.3.1A (Yield Limit Equations)

Bolt Diameter (in)	D	0.5	$F_{em, par}$	6160	K_{θ}	1.250	I_m	1631
Main Member Thickness (in)	$t_{m, min}$	4.5	$F_{em, perp}$	3626	$1+R_e$	1.042	III _s	1494
Side Member Thickness (in)	t_s	0.25	F_{em}	3626	$2+R_e$	2.042	IV	1960
Dowel Bearing Strength (psi)	F_{es}	87000	R_e	0.042	k_3	13.463		
Bolt Yield Strength (psi)	F_{yb}	106000						
Max Angle Load to Grain (deg)	θ	90						
Specific Gravity	G	0.55						
Reference Lateral Design Value (Z)	Z	1494		LRFD resistance factor		ϕ		0.65
ASD Load Duration Factor	C_D	1.6		LRFD time effect factor		λ		1
Geometry Factor	C_{Δ}	1		ASD to LRFD format conversion factor		K_F		3.32
ASD Adjusted Lateral Design Value (lbs)	$Z'_{b, ASD}$	2391		LRFD Adjusted Lateral Design Value (lbs)		$Z'_{b, LRFD}$		3224

TABLE 7C: LATERAL (SHEAR) STRENGTH OF EACH FASTENER GROUP									
Model	k_s	k_b	k_g	$Z'_{s,LRFD}$ (k_g/k_s)	$Z'_{b,LRFD}$ (k_g/k_b)	$Z'_{s,ASD}$ (k_g/k_s)	$Z'_{b,ASD}$ (k_g/k_b)	LRFD	ASD
	(lb/in)	(lb/in)	(lb/in)	(lb)	(lb)	(lb)	(lb)	ϕV (lb)	V_a (lb)
PC4600	32143	95459	159745	4081	5396	3026	4001	4081	3026
PC6300	32143	95459	159745	4081	5396	3026	4001	4081	3026
PC6400	32143	95459	159745	4081	5396	3026	4001	4081	3026
PC6600	32143	95459	159745	4081	5396	3026	4001	4081	3026
PC8300	32143	95459	224032	5723	7567	4243	5611	5723	4243
PC8400	32143	95459	224032	5723	7567	4243	5611	5723	4243
PC8500	32143	95459	224032	5723	7567	4243	5611	5723	4243

TABLE 7D: LOAD DISTRIBUTION RATIO AND LOAD-TO-STRENGTH RATIO						
Model	N_s	N_b	Load Distribution		Load / Strength	
			Screws	Bolts	Screws	Bolts
PC4600	2	1	40.2%	59.8%	100.0%	76%
PC6300	2	1	40.2%	59.8%	100.0%	76%
PC6400	2	1	40.2%	59.8%	100.0%	76%
PC6600	2	1	40.2%	59.8%	100.0%	76%
PC8300	4	1	57.4%	42.6%	100.0%	76%
PC8400	4	1	57.4%	42.6%	100.0%	76%
PC8500	4	1	57.4%	42.6%	100.0%	76%

TABLE 7E: BENDING STRENGTH OF STEEL-TO-WOOD CONNECTION						
Model	a (in)	s (in)	LRFD		ASD	
			ϕV_n (lb)	ϕM_n (lb-in)	V_n/Ω (lb)	M_n/Ω (lb-in)
PC4600	3.63	8.25	2830	33670	2100	24960
PC6300	3.63	8.25	2830	33670	2100	24960
PC6400	3.63	13.25	3200	54070	2380	40090
PC6600	3.63	8.25	2830	33670	2100	24960
PC8300	4.68	11.65	4080	66670	3030	49430
PC8400	4.68	11.65	4080	66670	3030	49430
PC8500	4.68	11.65	4080	66670	3030	49430

8. PERMA COLUMN: BENDING STRENGTH OF STEEL BRACKET (SADDLE AND REBAR)

The bending strength calculations for the Perma-Column steel bracket (saddle and rebar) are presented in both the LRFD and ASD formats in accordance with the provisions of the governing code (AISC 360-16). The calculations for the rebar development into the concrete pier are prepared using ACI 318-14. The calculations are completed using the finite element analysis in Visual Analysis by IES and Microsoft Excel (2016) using the listed equations.

In Visual Analysis, a 1000 lb-in moment is applied to each model in the form of horizontal forces, F_T and F_B , equal in magnitude and opposite in direction, applied at the centroid of the top and bottom fastener group, respectively. The restraint conditions for the finite element analysis models are described in Section 6. The resulting maximum internal bending moment, M_{max} , in units of (lb-in)/in, located anywhere in the bottom of the steel saddle, is reported in Table 8B. Figure 8 shows the concentration of the bending stresses in the steel saddle (saddle is shown up-side-down). To determine the design (LRFD) and allowable (ASD) bending strengths of the steel saddle, the ratio $(1000 / M_{max})$ is multiplied by the design (LRFD) and allowable (ASD) strengths of the steel saddle plate (the plate design is based on the 1" wide segment to be consistent with internal moment units used in the Visual Analysis). This method ensures that, if a moment equal to the design (LRFD) or allowable (ASD) strength of the steel bracket is applied to the bracket, the resulting maximum internal bending moment located anywhere in the saddle is equal to the design (LRFD) and allowable (ASD) bending strength of the steel plate from which the saddle is made.

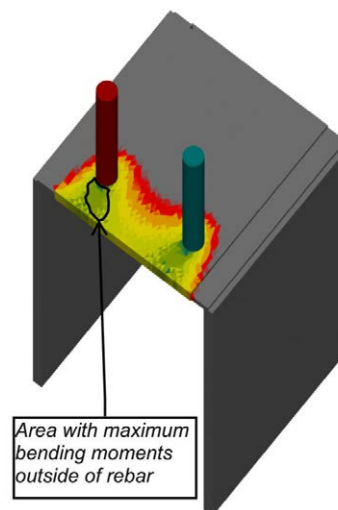

Figure 8: Visual Analysis Model

The design and allowable bending strengths for each model based on the tensile strength of rebar and weld connections are shown in Table 8A. The design and allowable bending strength of the steel bracket is controlled by the bending strength of the 1/4" thick steel saddle (Table 8B). Calculations for fastener bearing against the hole edges, calculations for shear strength and tension strength of steel plates, and calculations for block shear strength are not expected to control the design and are not provided. The minimum length required for the rebar to achieve full strength is provided in Table 8C.

GOVERNING CODE:

Specification for Structural Steel Buildings ANSI/AISC 360-16
Building Code Requirements for Structural Concrete, ACI 318-14

GOVERNING EQUATIONS:

- REBAR TENSILE STRENGTH: AISC 360, SECTION D2

Design Tensile Strength	$\phi P_n = \phi F_y A_g$	$\phi = 0.90$	(D2-1)
Allowable Tensile Strength	$P_n / \Omega = F_y A_g / \Omega$	$\Omega = 1.67$	(D2-1)

- WELDS: AISC 360, SECTION J2

Design Strength	$\phi R_n = \phi F_w A_w$	$\phi = 0.75$	(J2-3)
Allowable Strength	$R_n / \Omega = F_w A_w / \Omega$	$\Omega = 2.00$	(J2-3)
	$F_w = 0.60 F_{EXX}$		(T. J2.5)
	$A_w = L t_e$, where L = length of weld, t_e = effective weld thickness		

- BENDING IN STEEL SADDLE: AISC 360, SECTIONS F1 & F11

Design Bending Strength	$\phi M_n = \phi F_y Z$	$\phi = 0.90$	(F1, F11)
Allowable Bending Strength	$M_n / \Omega = M_n Z / \Omega$	$\Omega = 1.67$	(F1, F11)

- REBAR DEVELOPMENT REQUIREMENTS, ACI 318, Equation 25.4.2.3a

Development Length	$L_d = [(3/40)(f_y / \sqrt{f'_c}) (\Psi_t \Psi_e \Psi_s) / c_b] d_b^2$	(ACI 318, Eq. 25.4.2.3a)
--------------------	--	--------------------------

CALCULATIONS:

REBAR PROPERTIES (ASTM A706)			WELD PROPERTIES		
Rebar Yield Strength, F_y	60	ksi	Effective Weld Thickness (throat) , t_e	0.25	in
#4 Rebar Section Area, A_s	0.20	in ²	Total Weld Length, L, for #4 rebar	1.57	in/bar
#5 Rebar Section Area, A_s	0.31	in ²	Total Weld Length, L, for #5 rebar	1.96	in/bar
			Effective Weld Area, $A_w = L t_e$ for #4	0.39	in ² /bar
			Effective Weld Area, $A_w = L t_e$ for #5	0.49	in ² /bar
STEEL PLATE PROPERTIES			Electrode Classification Number	70	ksi
Minimum Yield Strength, F_y	40	ksi	Nominal Strength of Weld Metal, F_w	42	ksi
Thickness of steel, t	0.25	in			

Table 8A: BENDING STRENGTH BASED ON REBAR AND WELD STRENGTH

Model	$N_T A_s$ (in ²)	ϕP_n (lbf)	P_n / Ω (lbf)	$N_T A_w^{(1)}$ (in ²)	ϕR_n (lbf)	R_n / Ω (lbf)	d (in)	LRFD	ASD
								ϕM_n (in-lb)	M_n / Ω (in-lb)
PC4600	0.40	21600	14371	0.79	24728	16485	3.1	66960	44551
PC6300	0.40	21600	14371	0.79	24728	16485	3.1	66960	44551
PC6400	0.40	21600	14371	0.79	24728	16485	3.1	66960	44551
PC6600	0.40	21600	14371	0.79	24728	16485	3.1	66960	44551
PC8300	0.62	33480	22275	0.98	30870	20580	4.9	151263	100842
PC8400	0.62	33480	22275	0.98	30870	20580	4.9	151263	100842
PC8500	0.62	33480	22275	0.98	30870	20580	4.9	151263	100842

A_s = area of (one) tension rebar

N_T = quantity of tension rebar

d = distance between compression force and tension rebar

$\phi M_n = \min(\phi P_n, \phi R_n) d$

$M_n / \Omega = \min(P_n / \Omega, R_n / \Omega) d$

Table 8B: BENDING STRENGTH BASED ON BENDING OF STEEL SADDLE

Model ID	Bending Strength of 1" wide Plate Sample			Bending Strength of Steel Saddle					
	w (in)	t (in)	Z (in ³)	ϕM_n (in-lb)	M_n / Ω (in-lb)	M (in-lb)	M_{max} (in-lb/in)	LRFD ϕM_n (in-lb)	ASD M_n / Ω (in-lb)
PC4600	1.00	0.50	0.0625	2250	1497	1000	48	46875	31188
PC6300	1.00	0.50	0.0625	2250	1497	1000	48	46875	31188
PC6400	1.00	0.50	0.0625	2250	1497	1000	48	46875	31188
PC6600	1.00	0.50	0.0625	2250	1497	1000	48	46875	31188
PC8300	1.00	0.50	0.0625	2250	1497	1000	28	80357	53464
PC8400	1.00	0.50	0.0625	2250	1497	1000	28	80357	53464
PC8500	1.00	0.50	0.0625	2250	1497	1000	28	80357	53464

w = width of plate sample

t = thickness of steel plate at bottom of column (composite action)

$Z = w t^2 / 4$

Design Bending Strength of Steel Saddle, $\phi M_n = (M / M_{max})$ (design bending strength of steel plate)

Allowable Bending Strength of Steel Saddle, $M_n / \Omega = (M / M_{max})$ (allowable bending strength of steel plate)

TABLE 8C: REBAR DEVELOPMENT LENGTH												
Model ID	#	d _b (in)	f _y (ksi)	f' _c (ksi)	Ψ _t	Ψ _e	Ψ _s	C _{b, cover} (in)	C _{b, 1/2 sp} (in)	L _d (in)	L _r (in)	Developed %
PC4600	4	0.5	60000	10000	1.0	1.5	0.8	1.25	0.75	18.0	60	100%
PC6300	4	0.5	60000	10000	1.0	1.5	0.8	1.25	1.19	11.3	60	100%
PC6400	4	0.5	60000	10000	1.0	1.5	0.8	1.25	1.94	10.8	60	100%
PC6600	4	0.5	60000	10000	1.0	1.5	0.8	1.25	1.69	10.8	60	100%
PC8300	5	0.625	60000	10000	1.0	1.5	0.8	1.25	1.13	18.7	60	100%
PC8400	5	0.625	60000	10000	1.0	1.5	0.8	1.25	1.88	16.9	60	100%
PC8500	5	0.625	60000	10000	1.0	1.5	0.8	1.25	2.59	16.9	60	100%

9. SKIRT BOARD ATTACHMENT

A skirt board may be attached to the portion of the Perma-Column protruding from the ground with a maximum of four concrete screws requiring a maximum hole diameter of 3/16 inch (4.8 mm), and a hole depth of 1-1/4 inches (32 mm). A minimum edge distance of 1-1/2 inches (38 mm) must be provided (see Figure 9) and the holes must be spaced at least 2-1/2 inches (64 mm) apart.

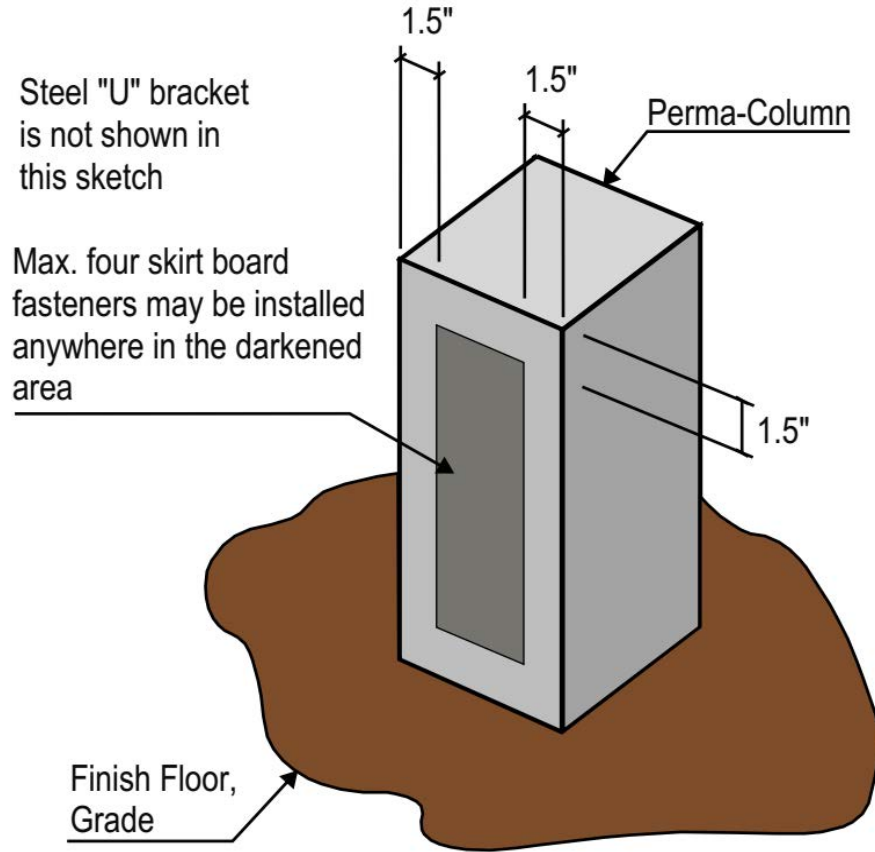
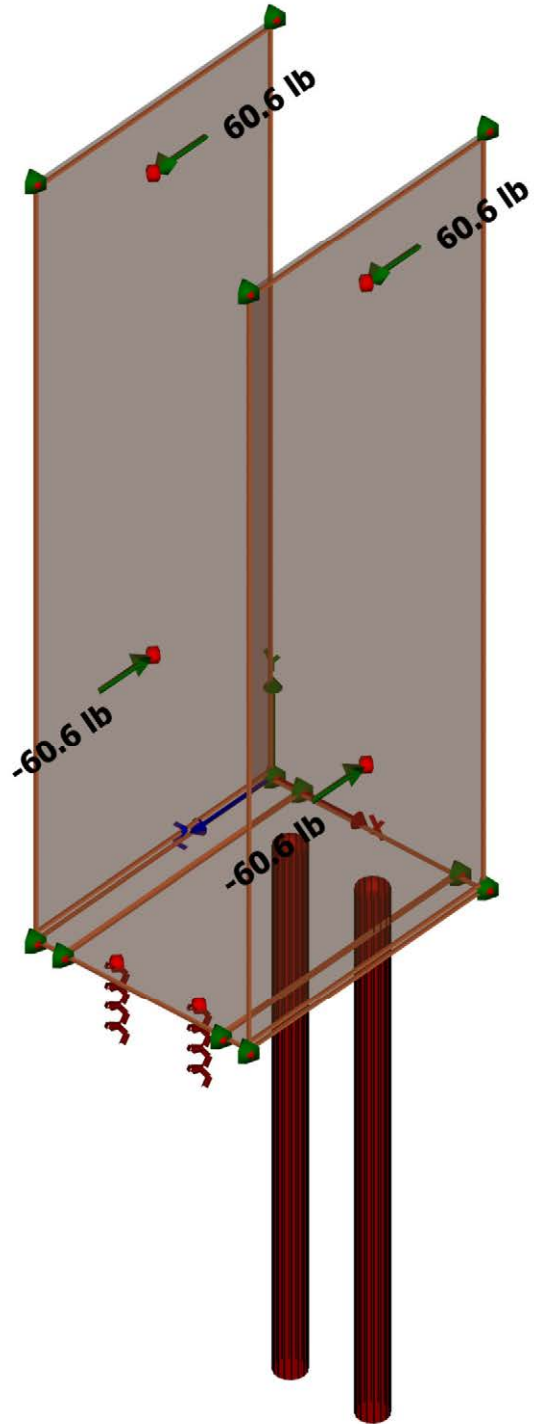

Figure 9: Placement of skirt board fasteners

APPENDIX A

Structural Models of Perma-Column Brackets (Finite Element Analysis) To Determine Rotational Stiffness and the Maximum Bending Moment (Unity) In Steel Bracket

Visual Analysis by IES, Inc



PC46 Finite Element Analysis.vap
Service Case: L
IES VisualAnalysis 19.00.0004
Thursday, June 11, 2020

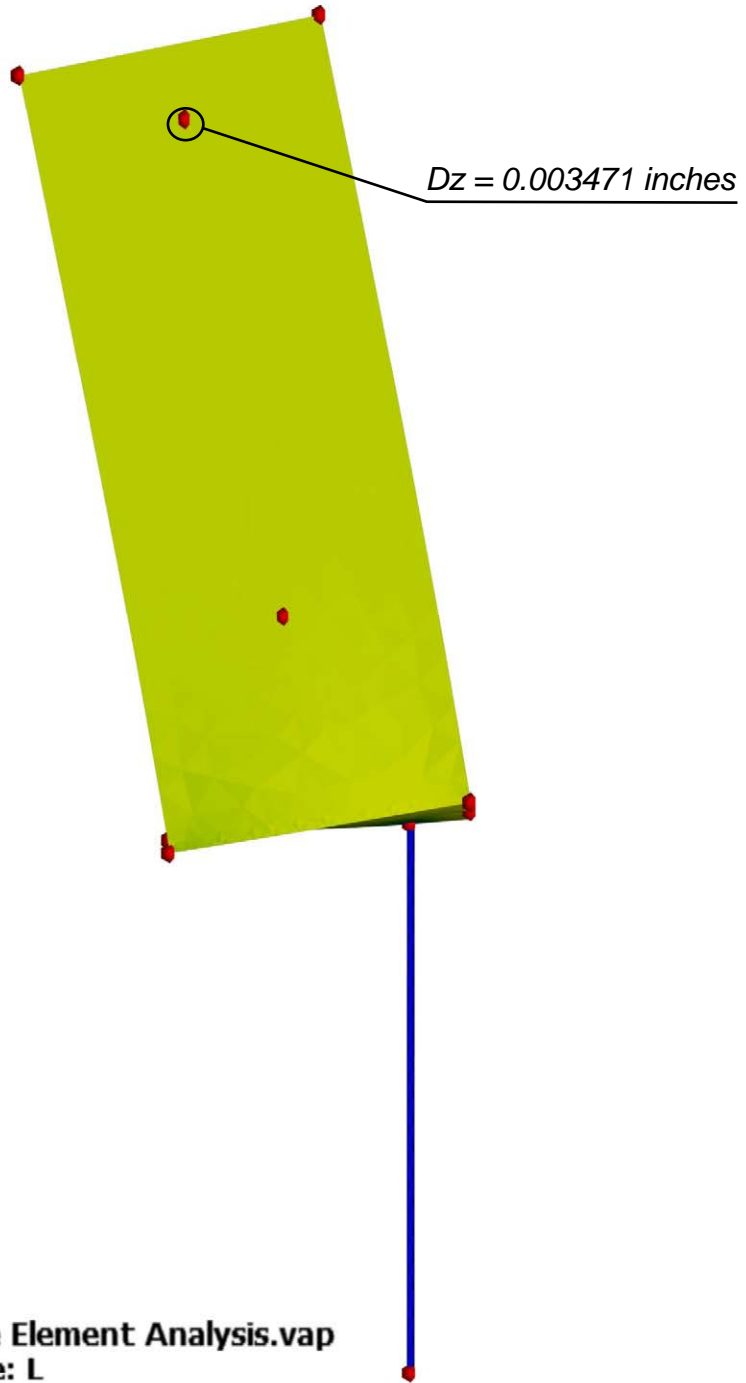

PC46 Finite Element Analysis.vap
Result Case: L
IES VisualAnalysis 19.00.0004
Thursday, June 11, 2020

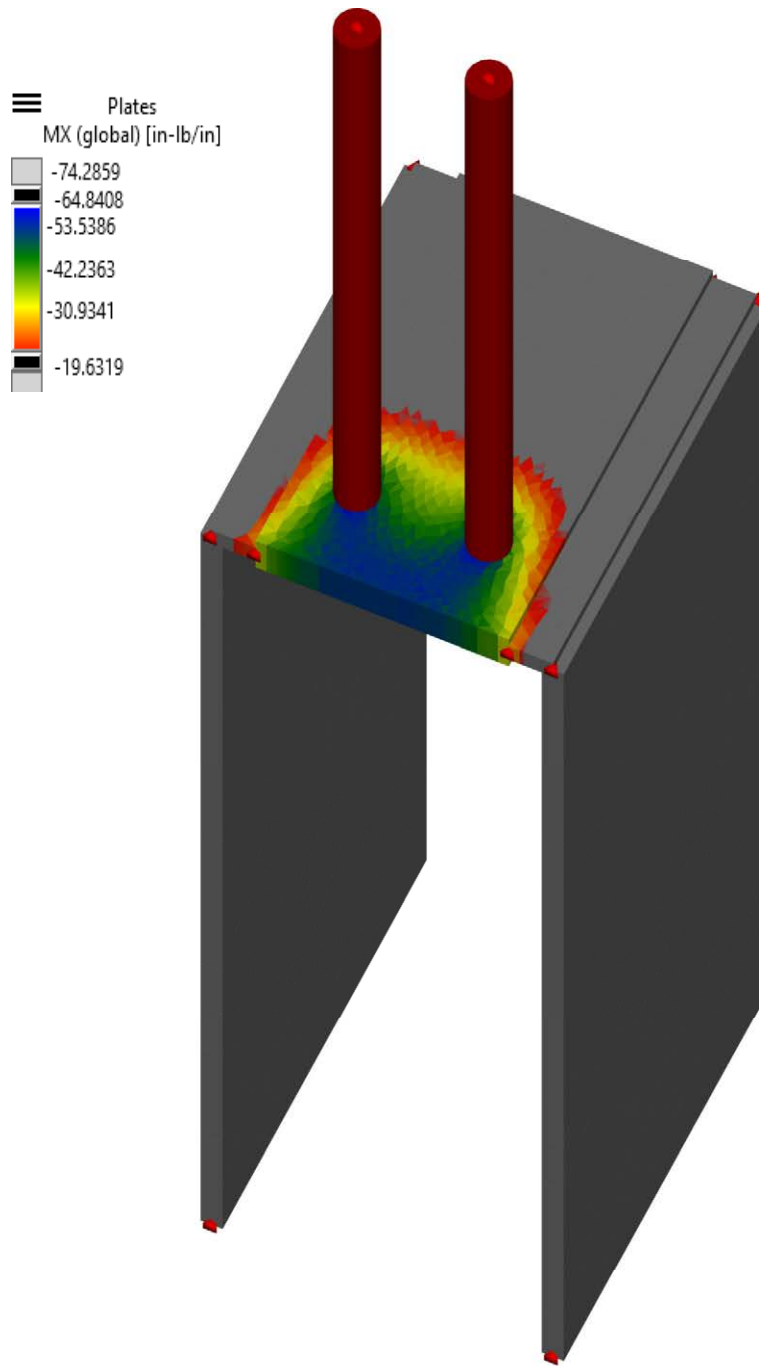

PC46 Finite Element Analysis.vap
Result Case: L
IES VisualAnalysis 19.00.0004
Thursday, June 11, 2020

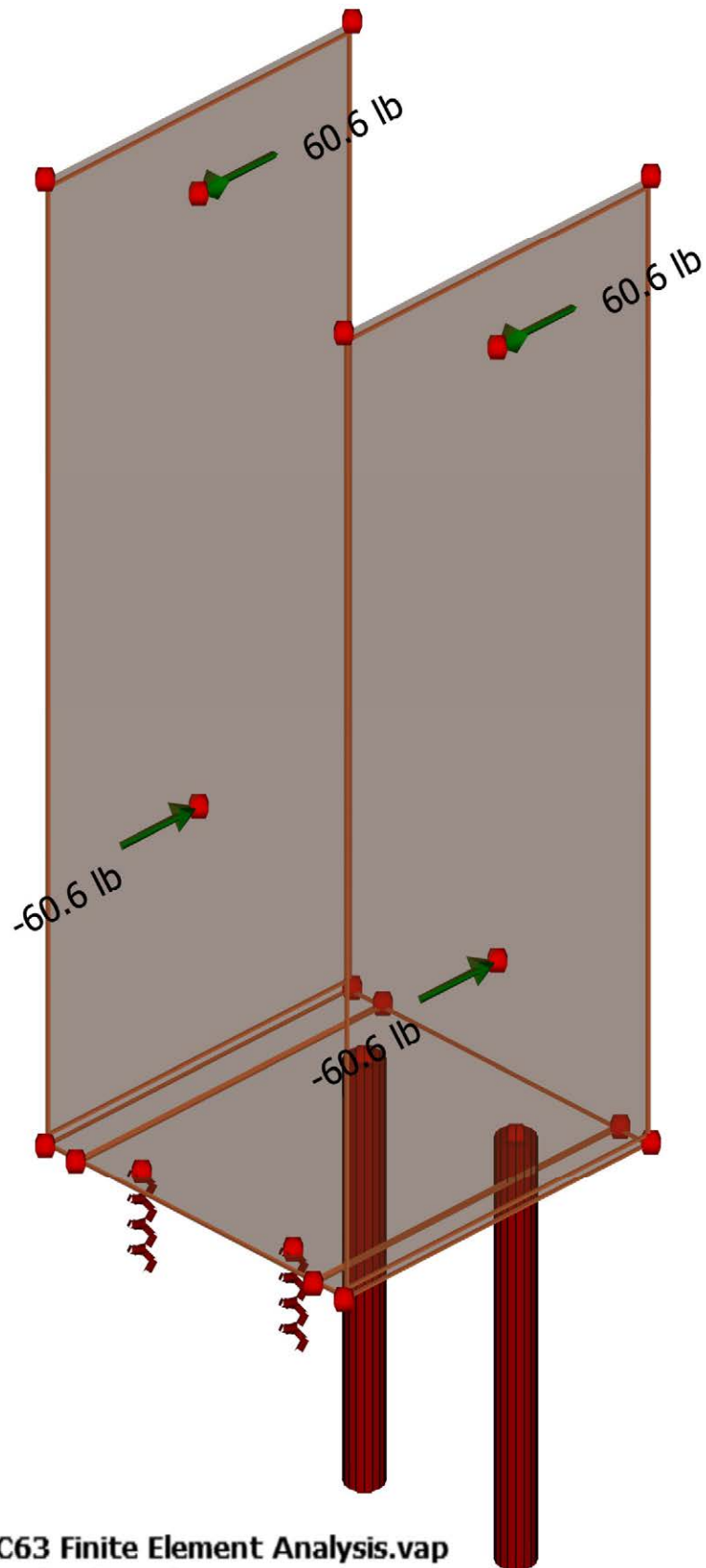

PC63 Finite Element Analysis.vap
Service Case: L
IES VisualAnalysis 18.00.0004
Friday, October 12, 2018

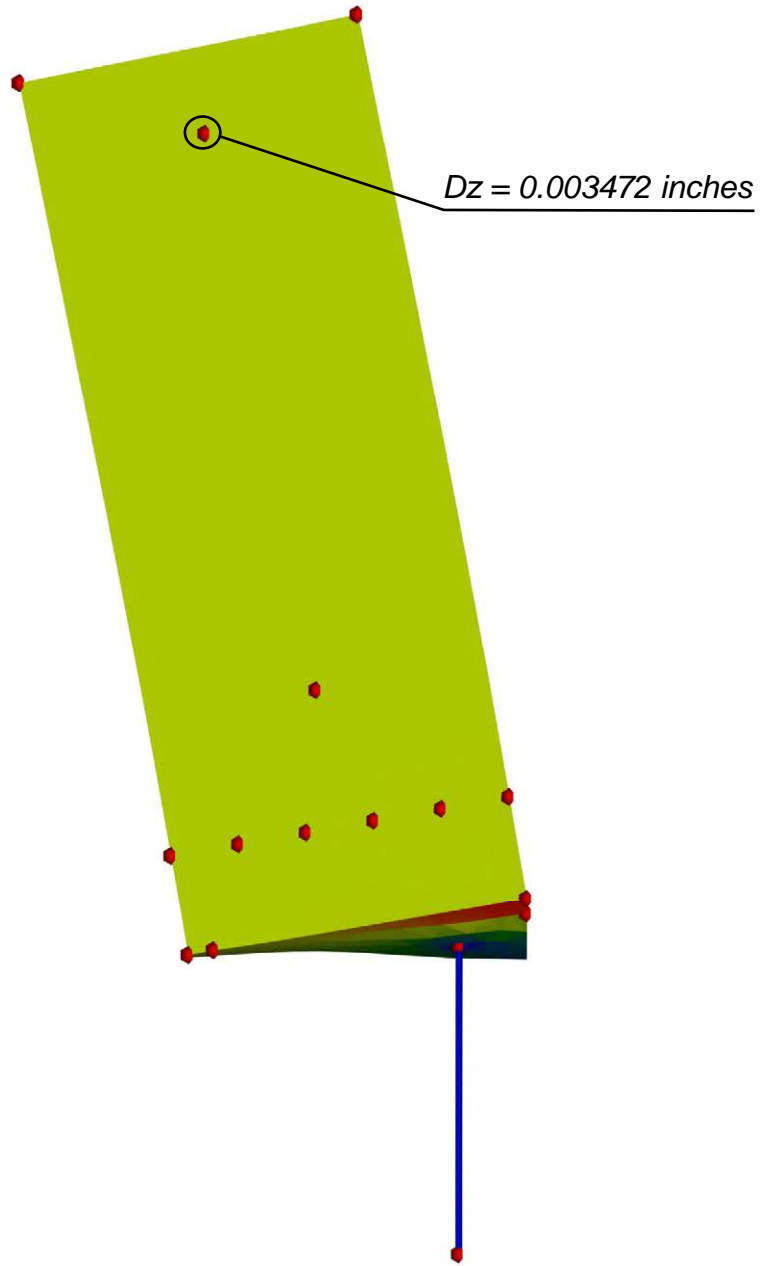

PC63 Finite Element Analysis.vap
Result Case: L
IES VisualAnalysis 18.00.0002
Thursday, June 14, 2018

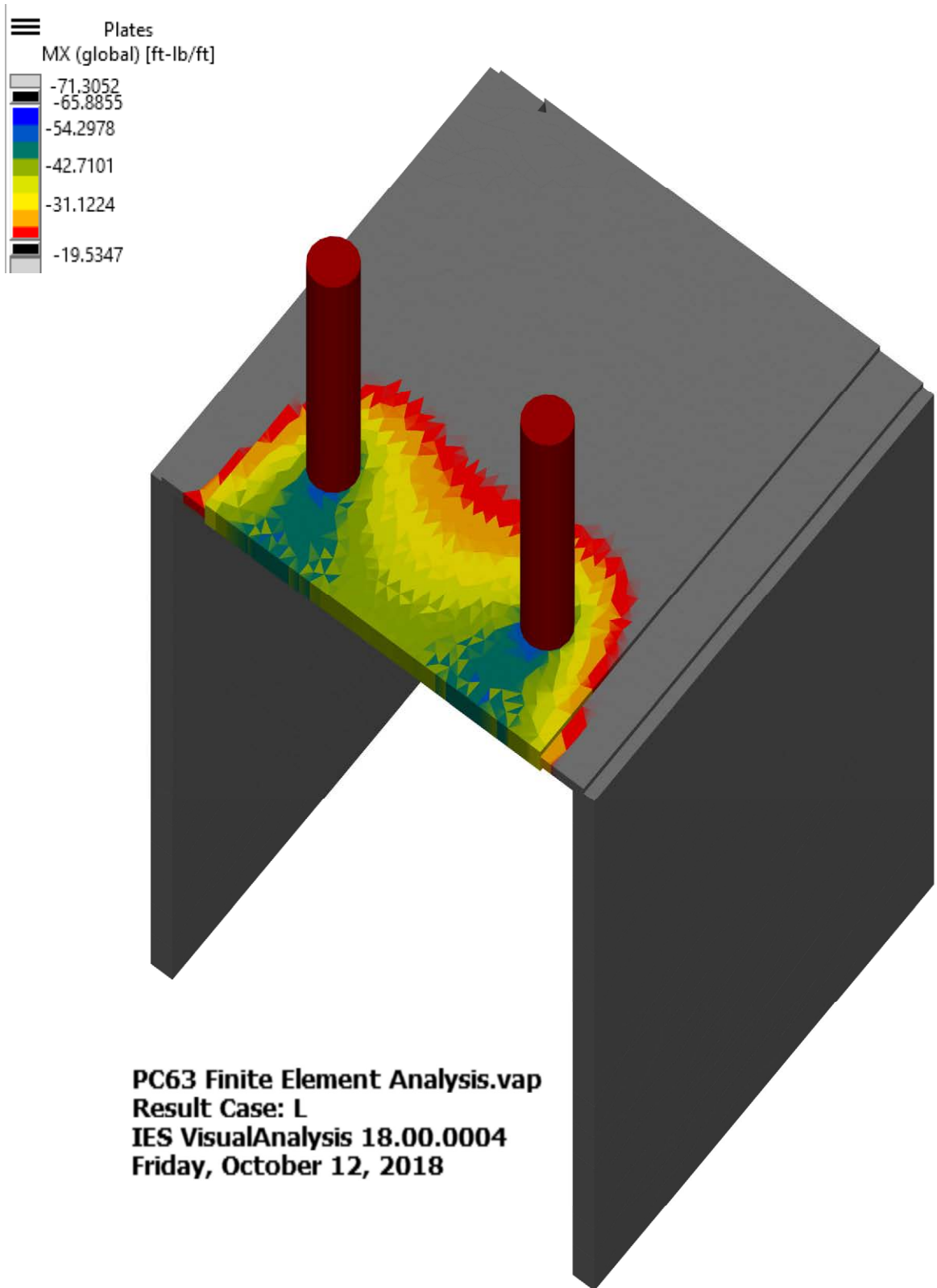

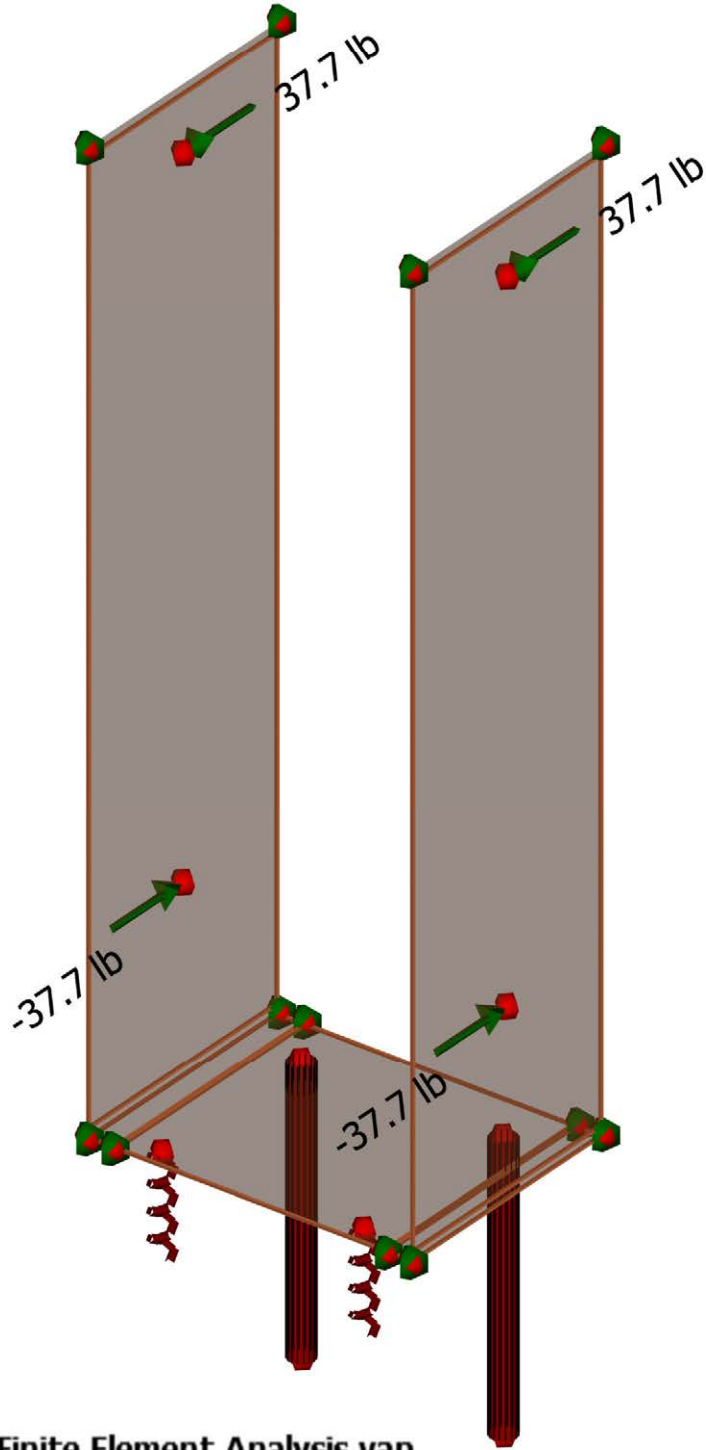

PC64 Finite Element Analysis.vap
Service Case: L
IES VisualAnalysis 18.00.0004
Friday, October 12, 2018

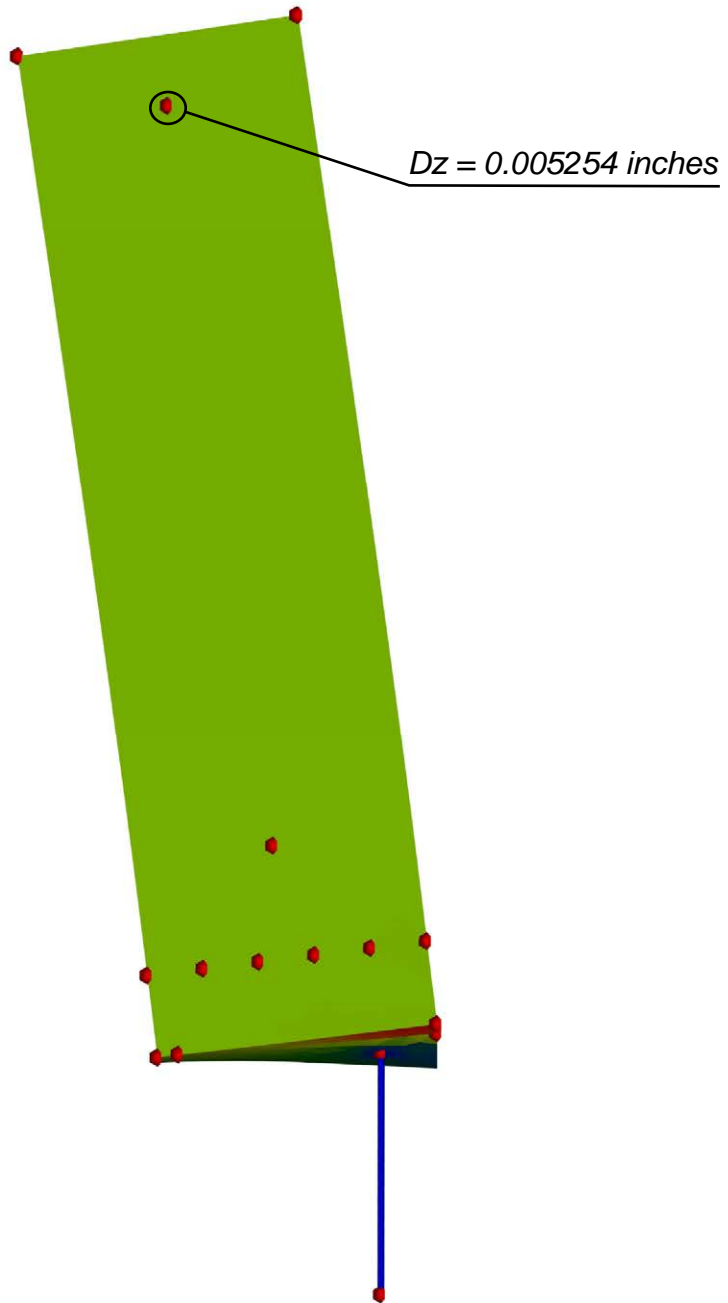

PC64 Finite Element Analysis.vap
Result Case: L
IES VisualAnalysis 18.00.0002
Thursday, June 14, 2018

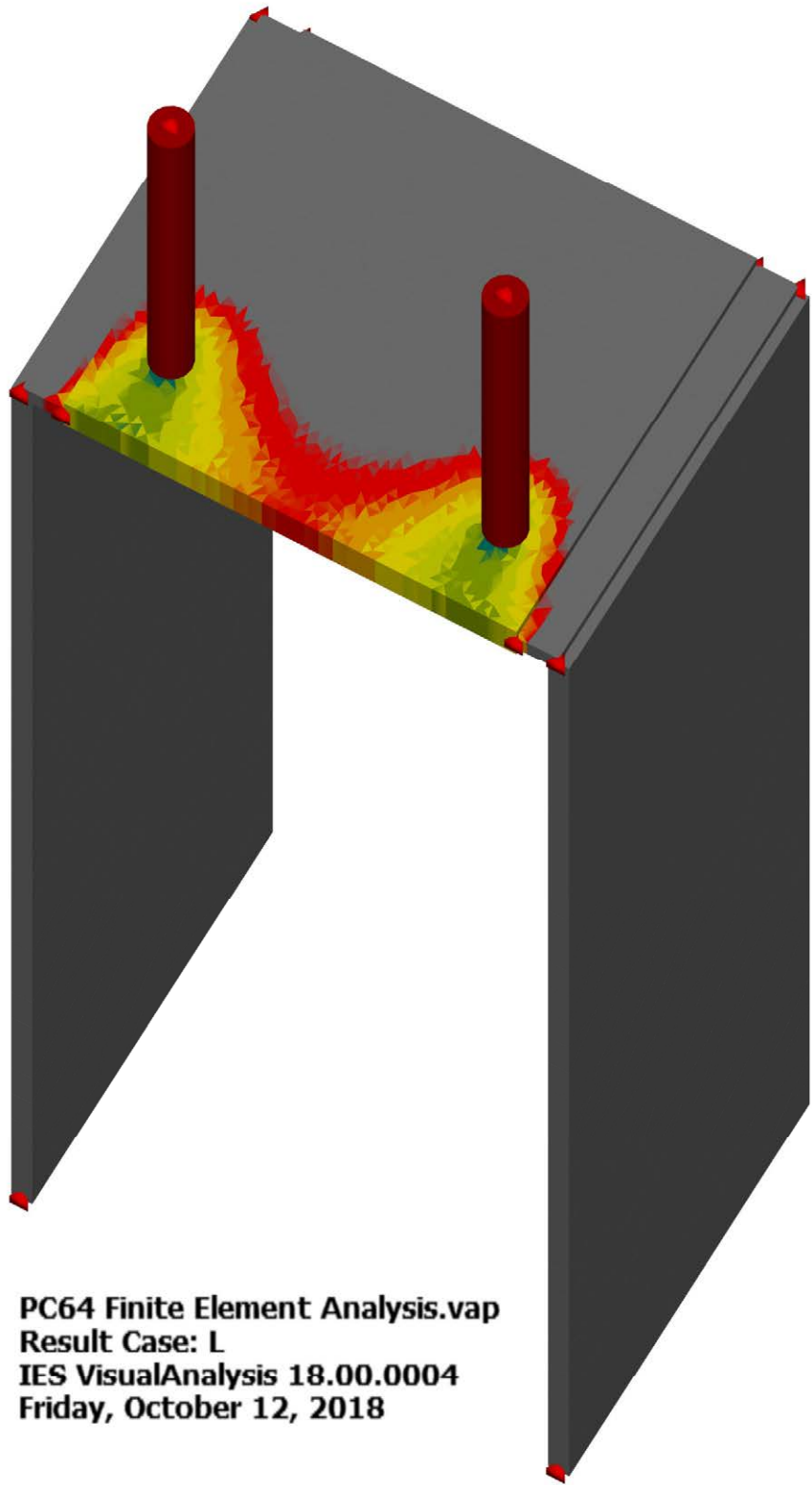
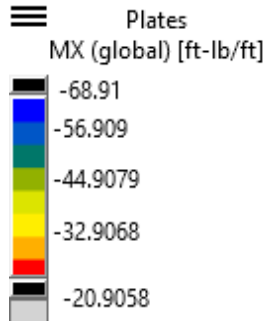

PC64 Finite Element Analysis.vap
Result Case: L
IES VisualAnalysis 18.00.0004
Friday, October 12, 2018

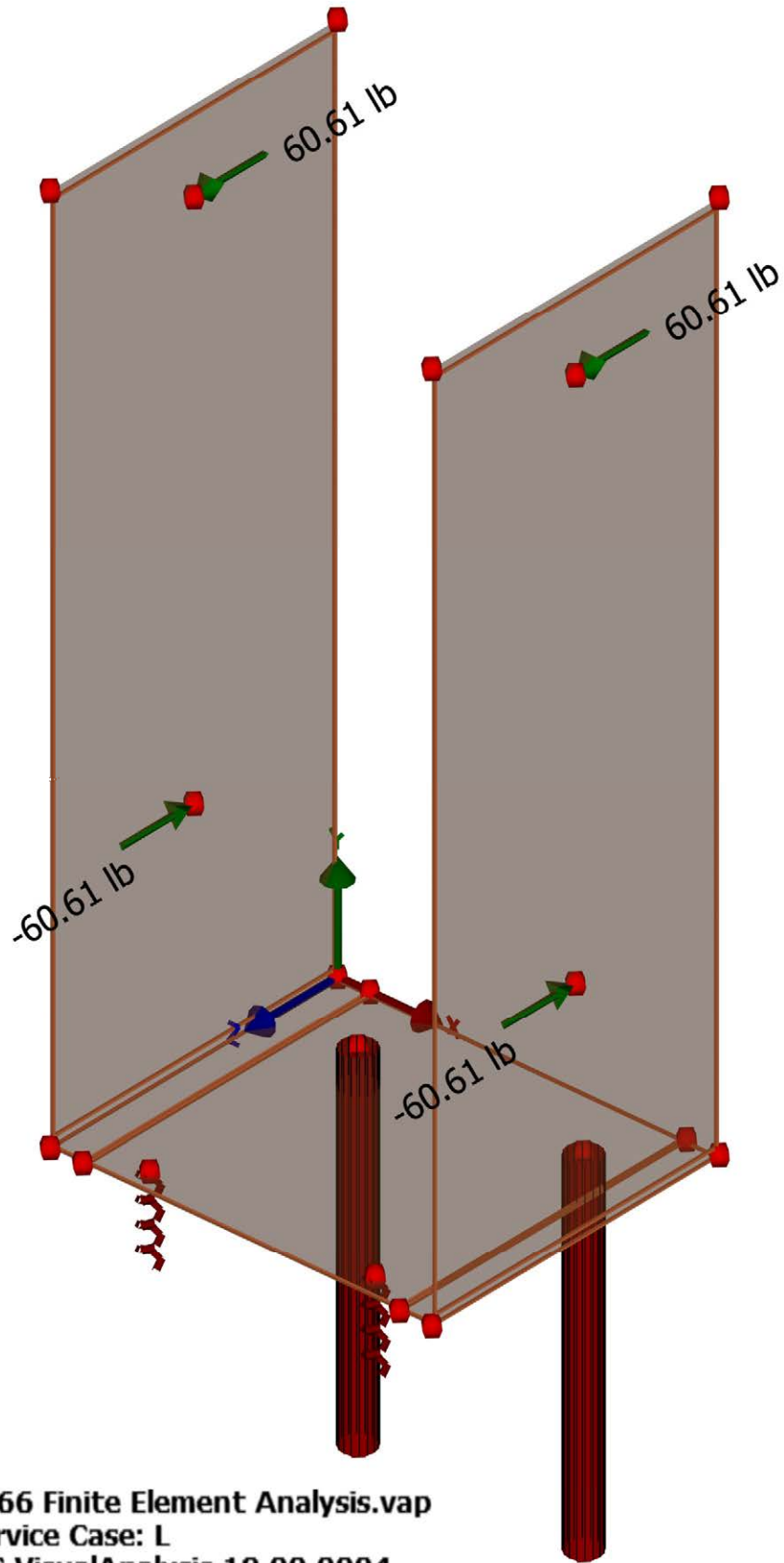

PC66 Finite Element Analysis.vap
Service Case: L
IES VisualAnalysis 18.00.0004
Friday, October 12, 2018

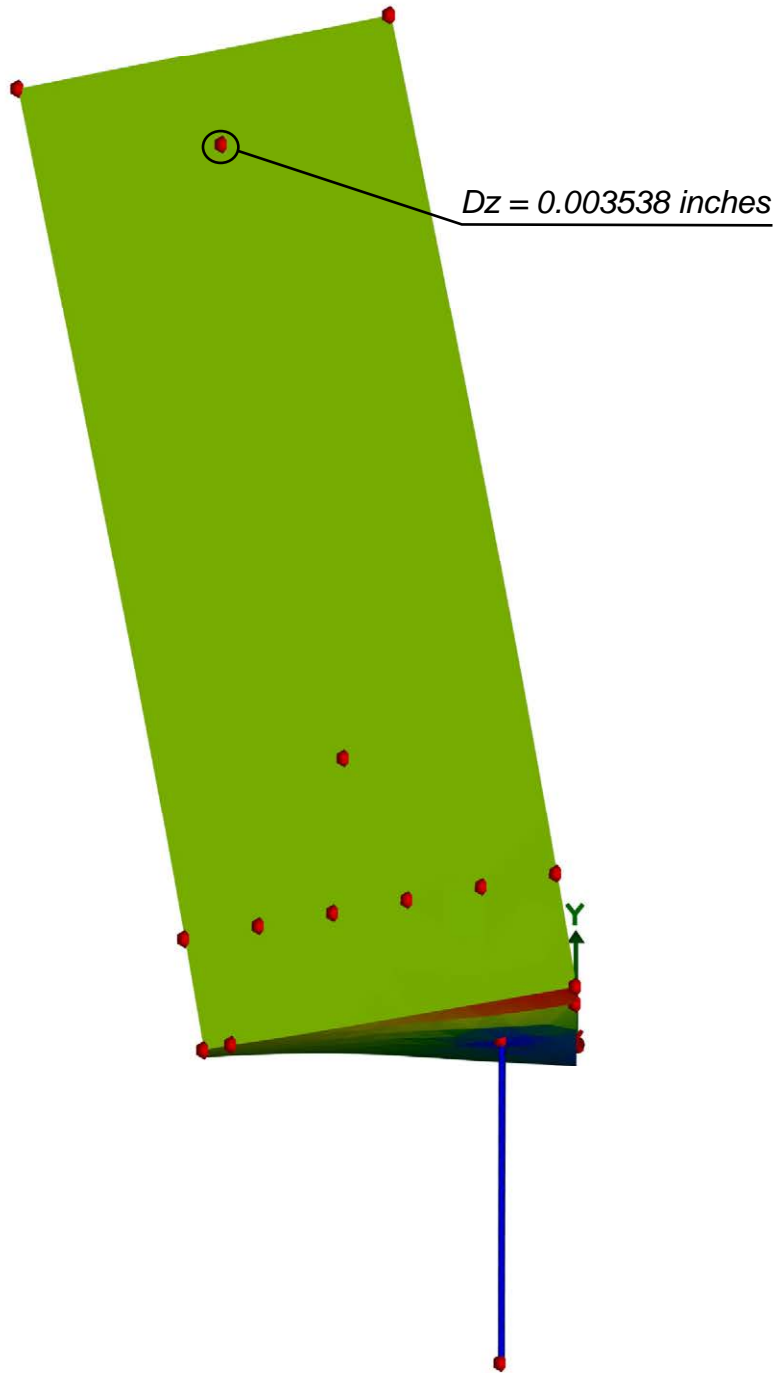

PC66 Finite Element Analysis.vap
Result Case: L
IES VisualAnalysis 18.00.0002
Thursday, June 14, 2018

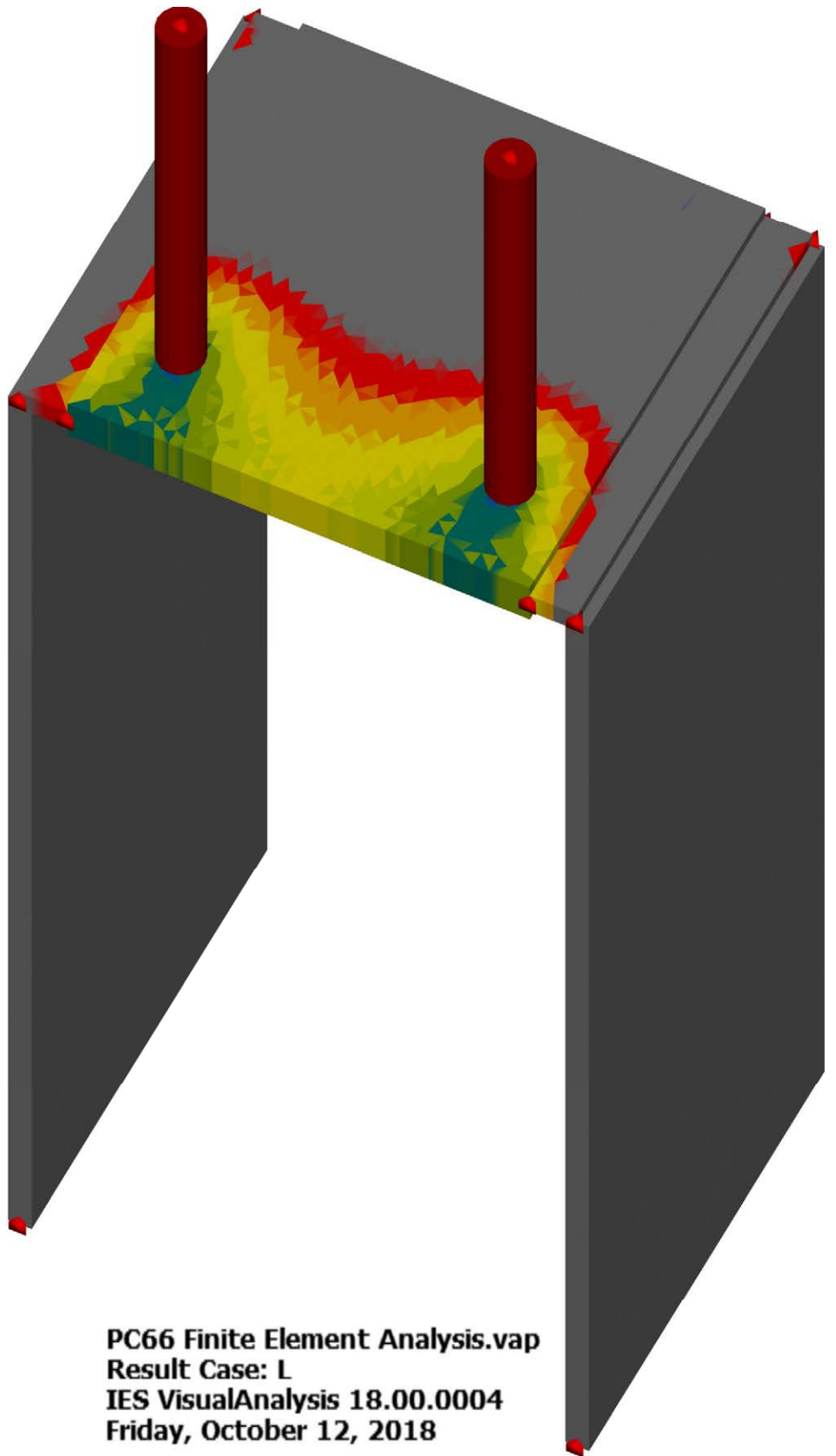

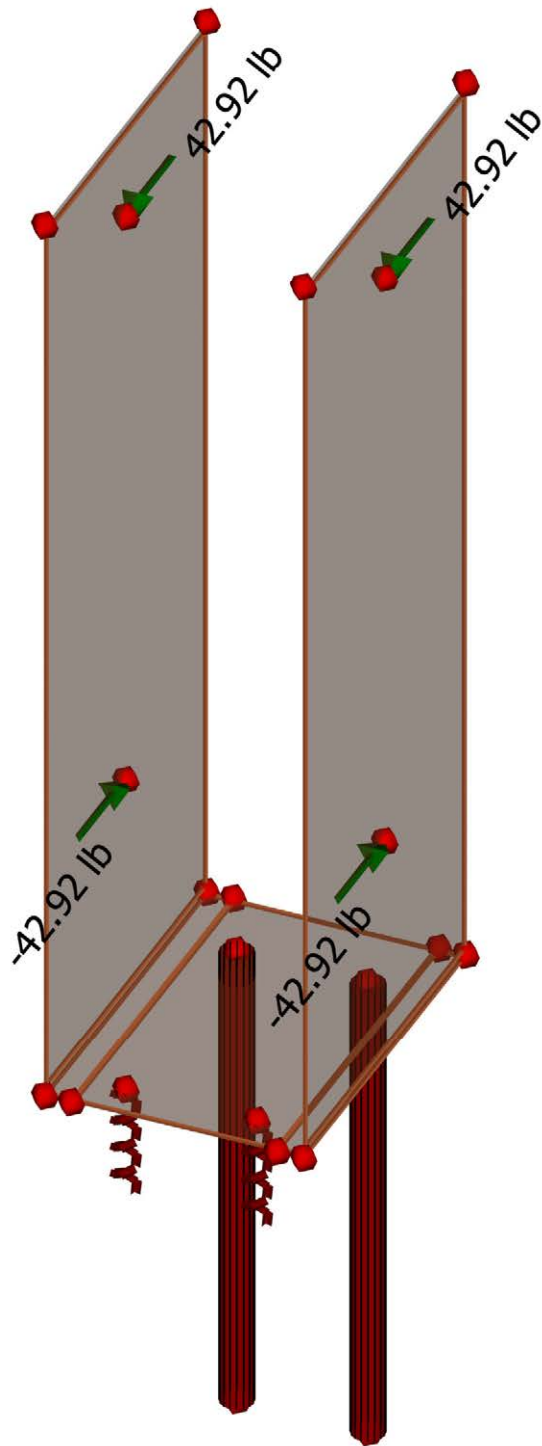

PC83 Finite Element Analysis.vap
Service Case: L
IES VisualAnalysis 18.00.0004
Friday, October 12, 2018

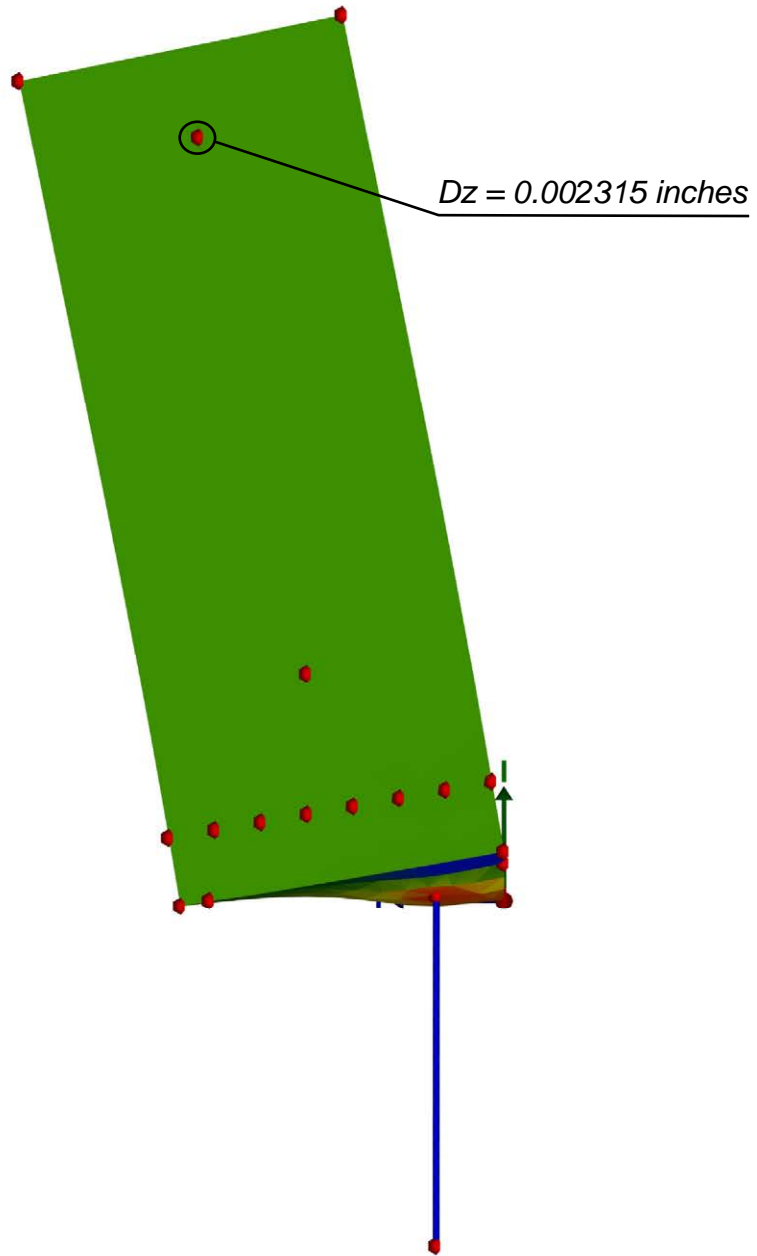

PC83 Finite Element Analysis.vap
Result Case: L
IES VisualAnalysis 18.00.0002
Thursday, June 14, 2018

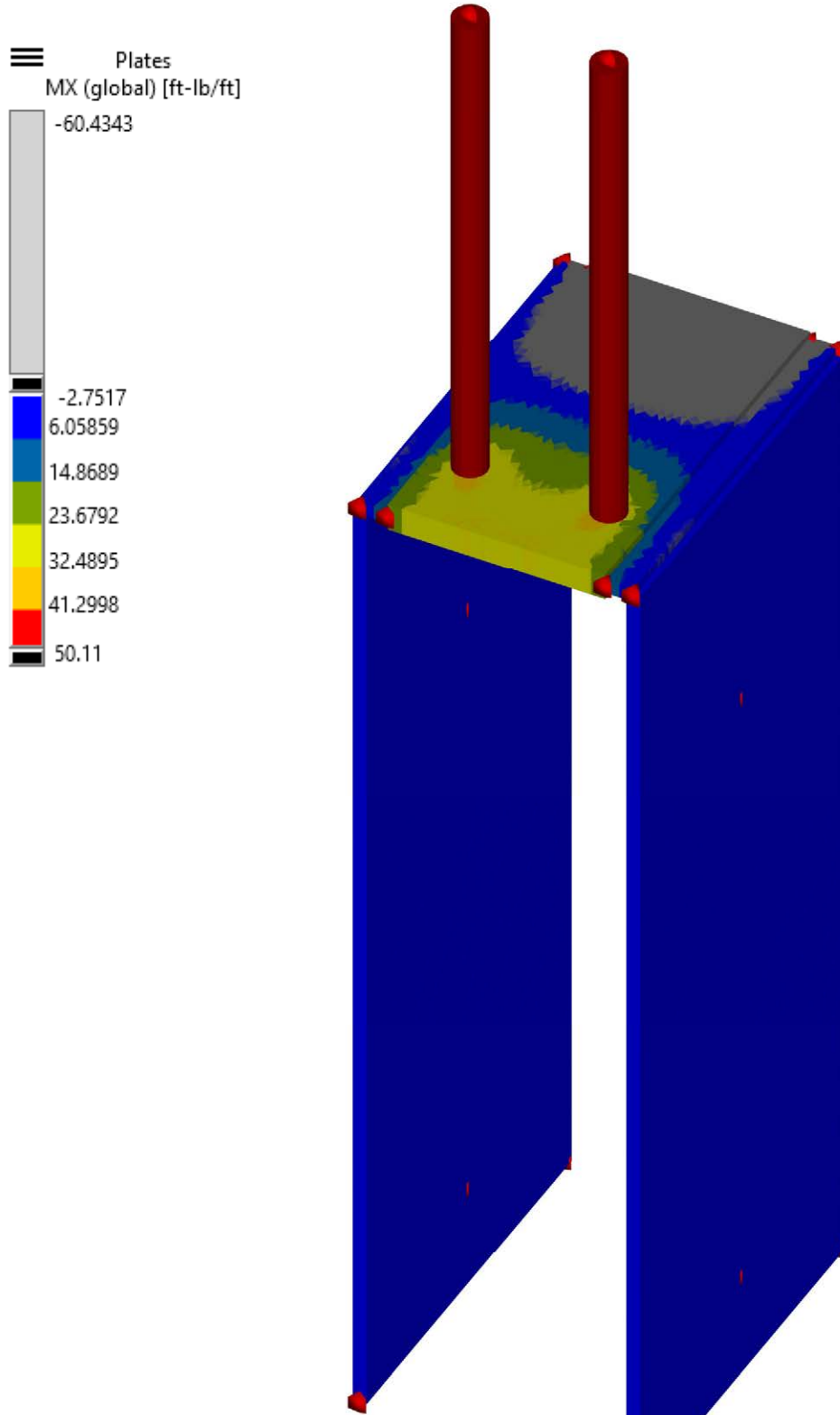

PC83 Finite Element Analysis.vap
Result Case: L
IES VisualAnalysis 18.00.0004
Friday, October 12, 2018

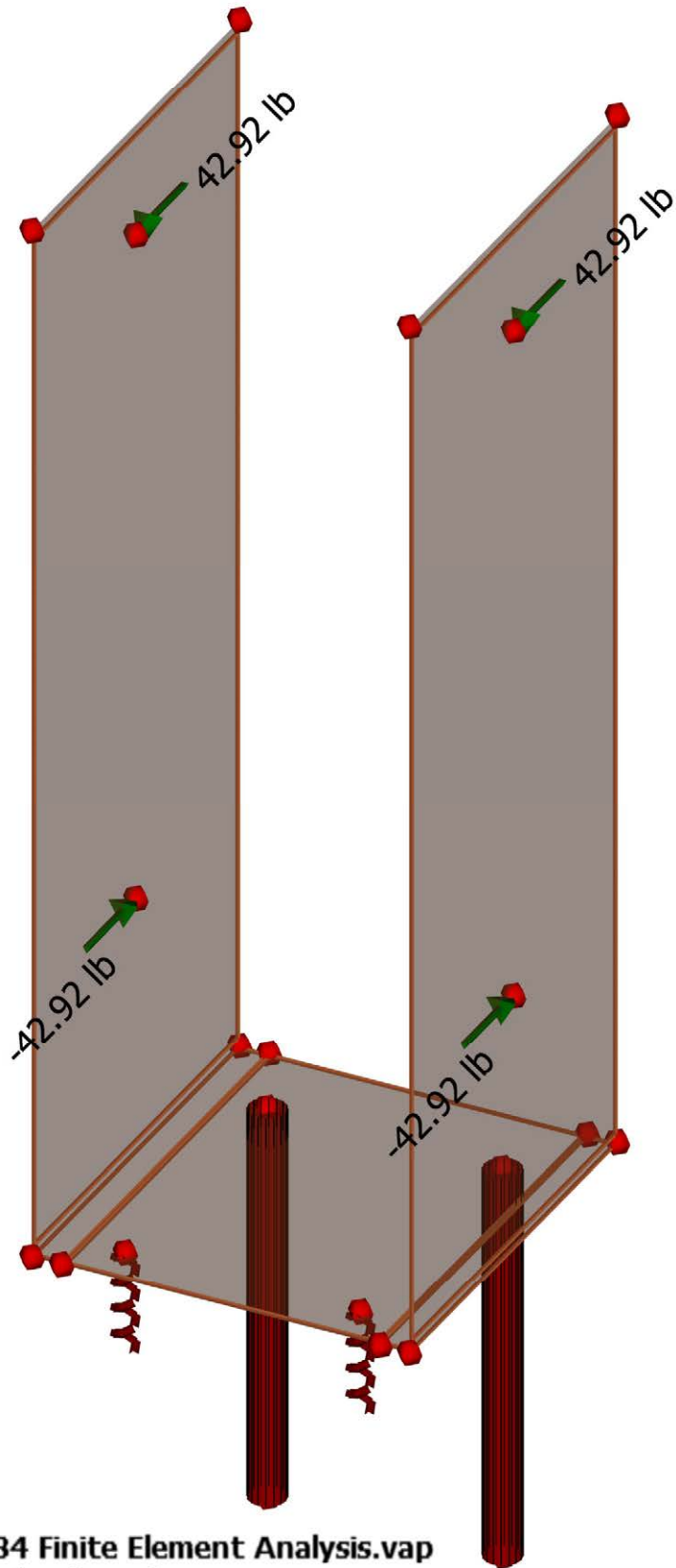

PC84 Finite Element Analysis.vap
Service Case: L
IES VisualAnalysis 18.00.0004
Friday, October 12, 2018

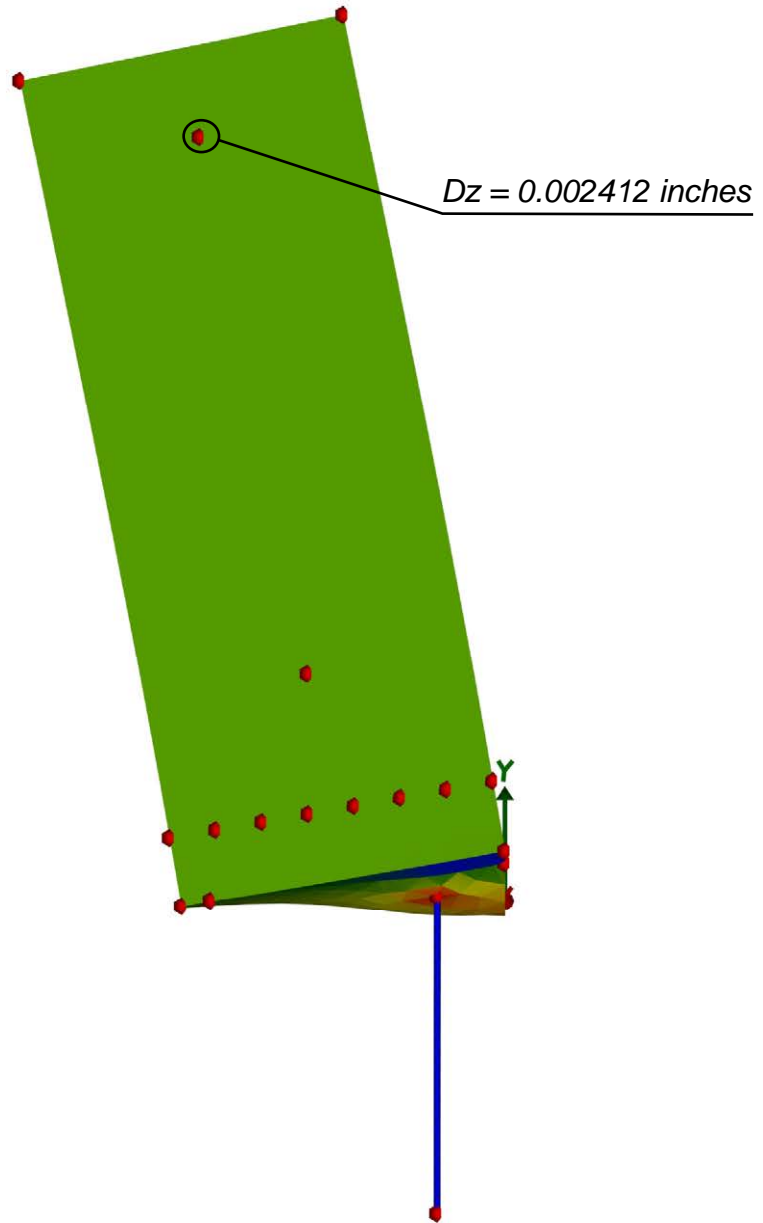

PC84 Finite Element Analysis.vap
Result Case: L
IES VisualAnalysis 18.00.0002
Thursday, June 14, 2018

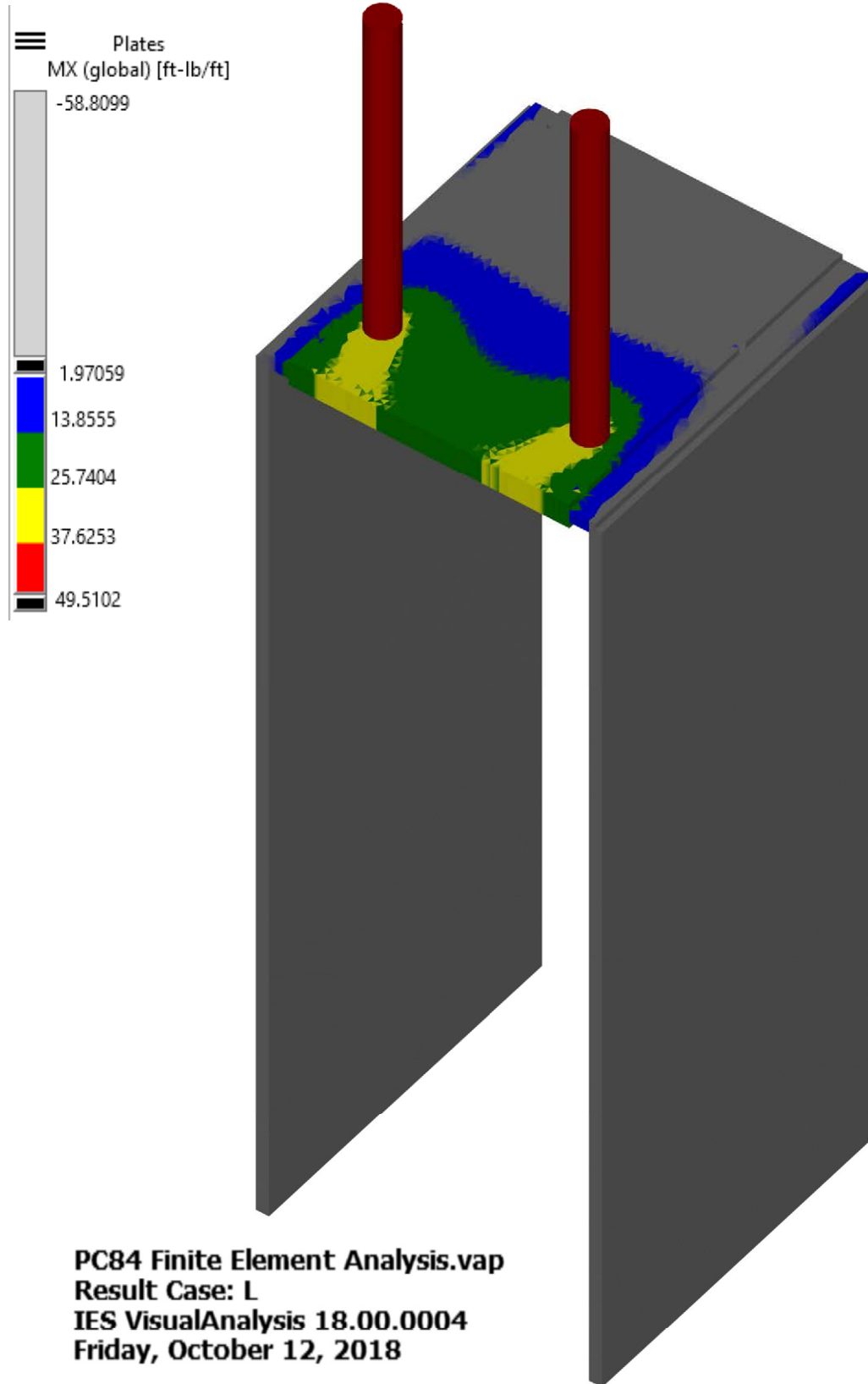

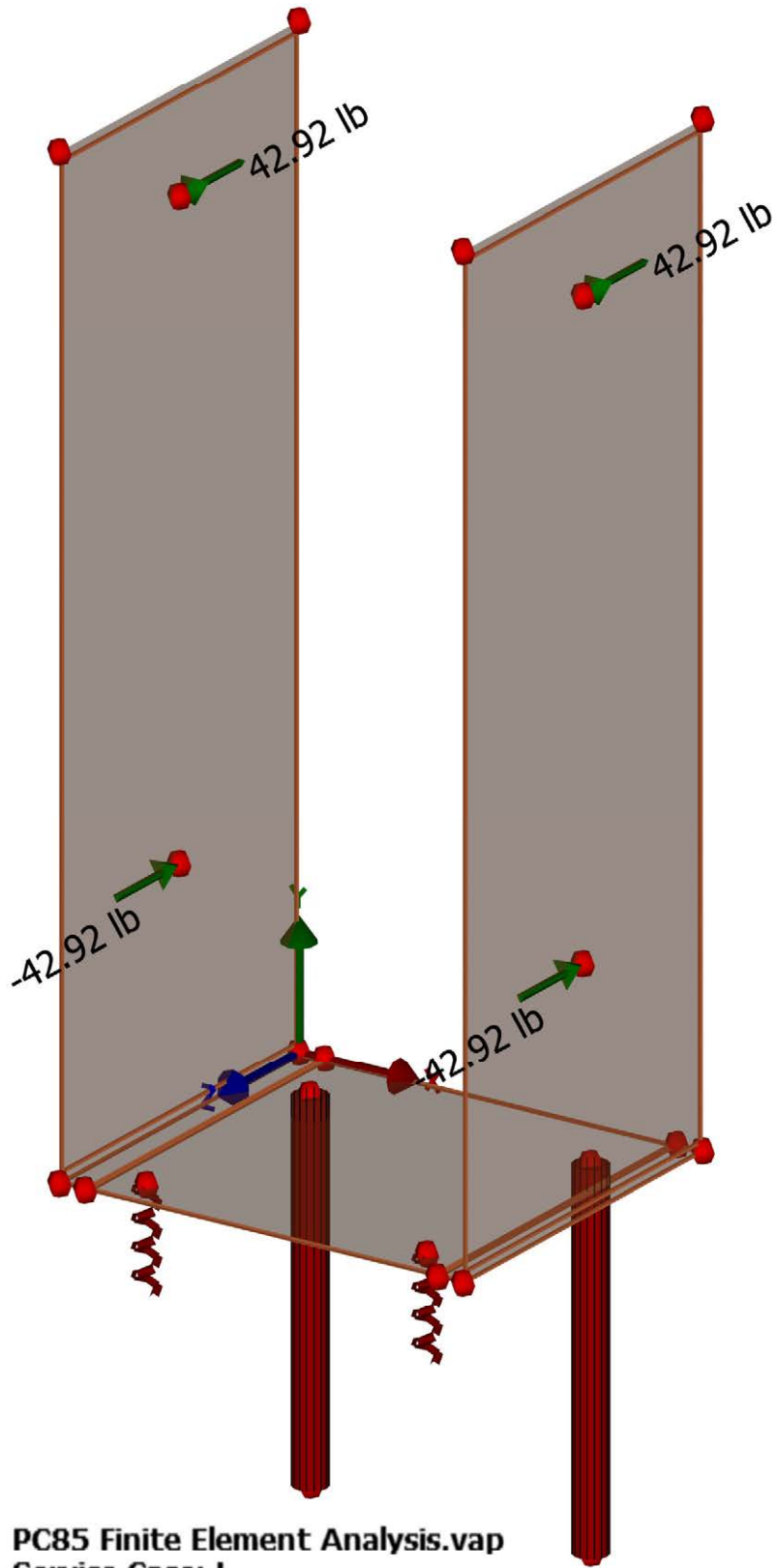

PC85 Finite Element Analysis.vap
Service Case: L
IES VisualAnalysis 18.00.0004
Friday, October 12, 2018

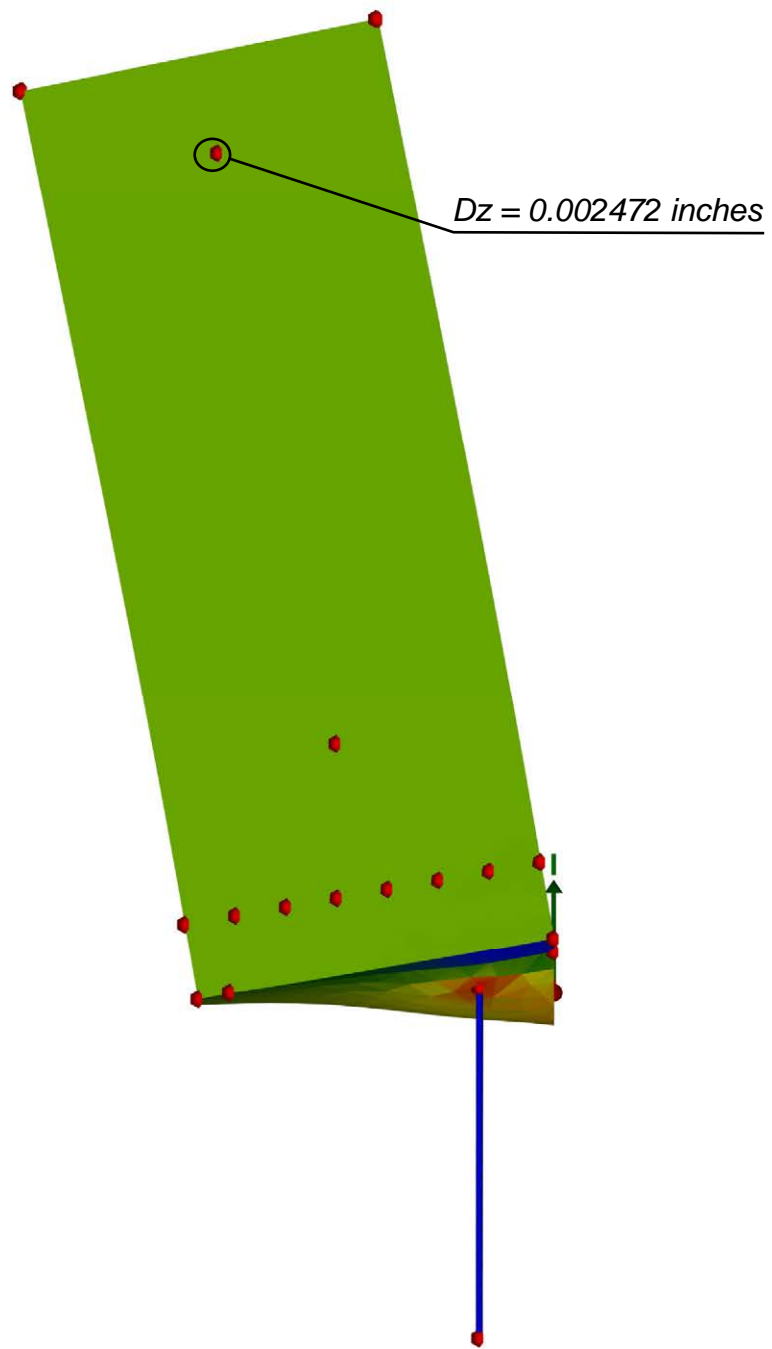

PC85 Finite Element Analysis.vap
Result Case: L
IES VisualAnalysis 18.00.0002
Thursday, June 14, 2018

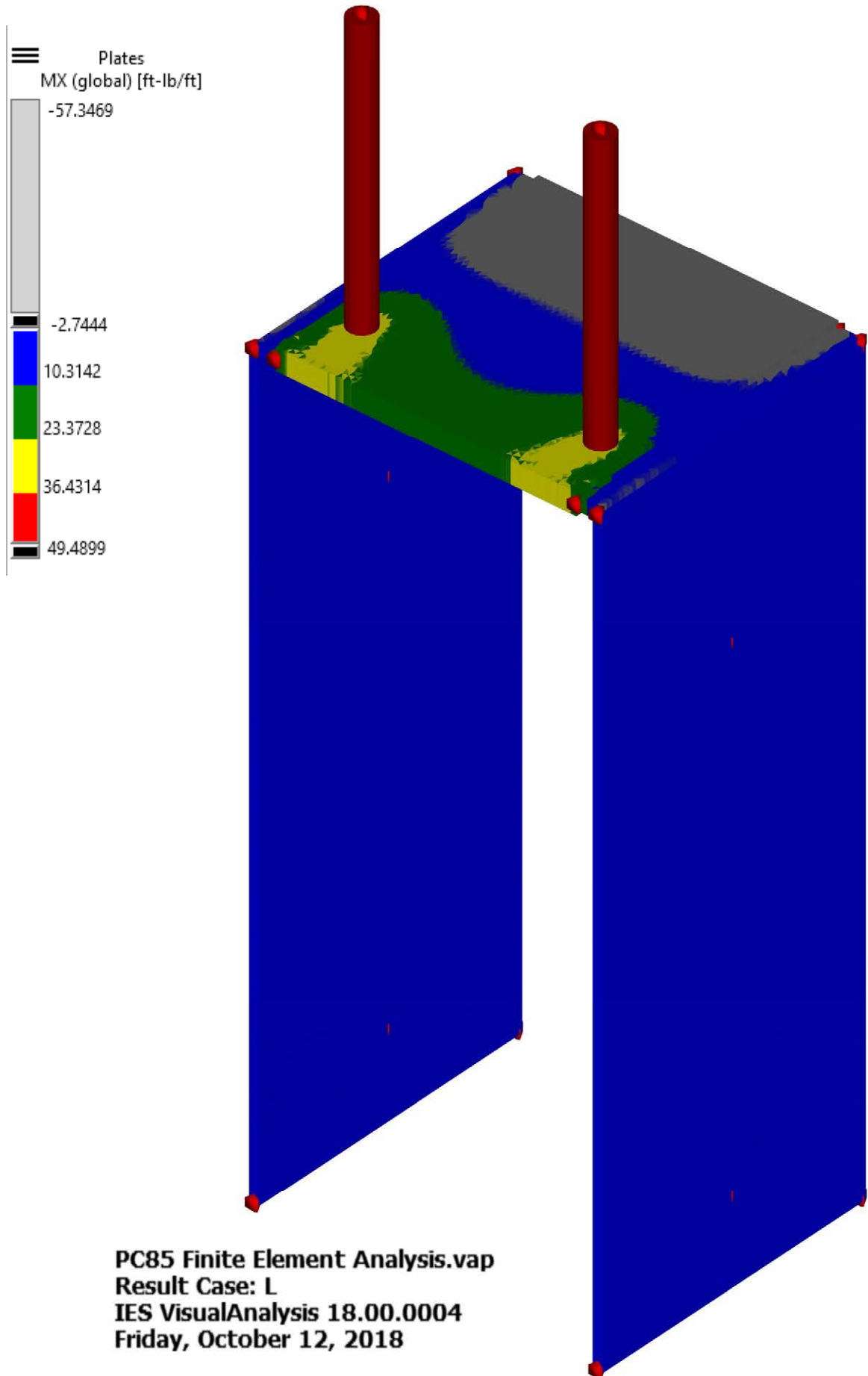

APPENDIX B

Structural Models of Perma-Column Brackets To Determine the Maximum Bending Moment (Unity) In Steel Bracket When Bracket is Subjected to Tensile (Uplift) Load

Visual Analysis by IES, Inc

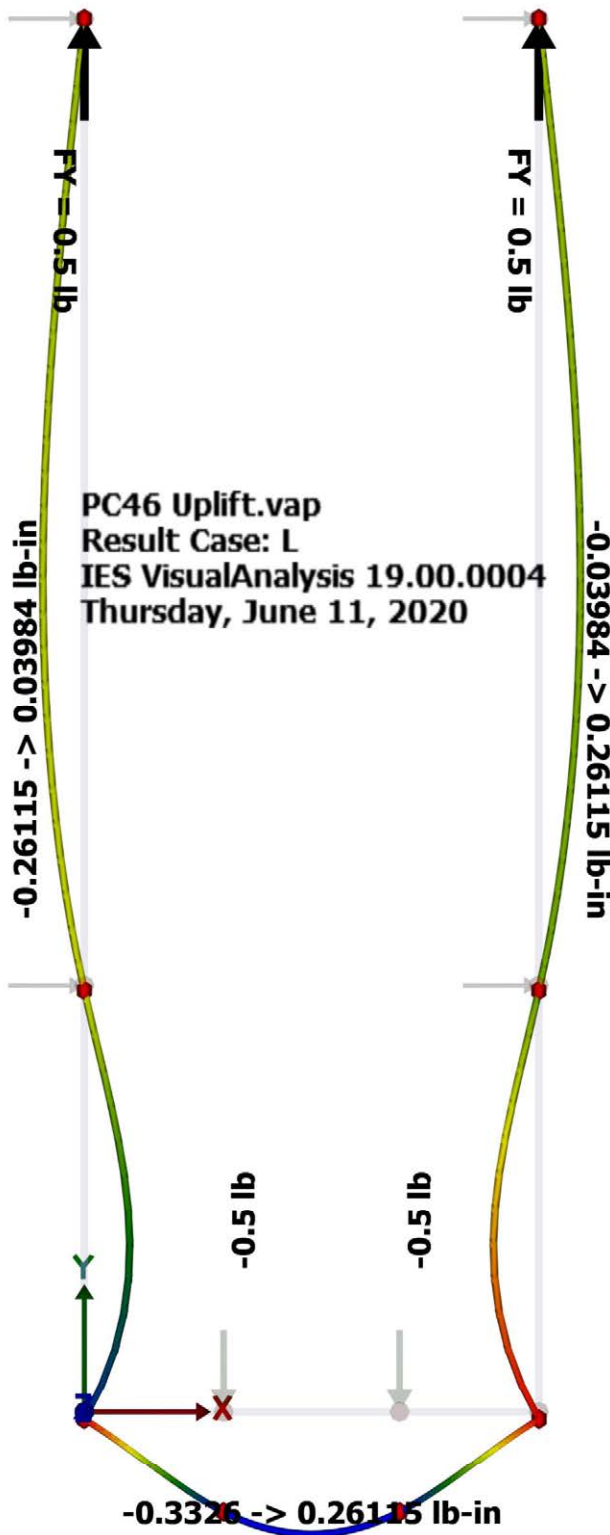

Members : My, moment [lb-in]



